

PROTEKT®

MANUFACTURER OF FALL PROTECTION EQUIPMENT

ARBORISTS EQUIPMENT

TreeUP

Harness for arborists
Safety harness
Warning vest
Tree climbing spikes and spare parts
Work positioning device
Tool straps
Lifting and lowering device
Pulleys and pulleys block
Carabiners
Telescopic poles
Ropes
Prusiks
Accessories
Arborist's trolleys

5



2024/25

The TREEUP brand is owned by PROTEKT, a company which has been on the market for over 25 years.

The PROTEKT Company is dedicated to equipment designed for arresting falls from heights. The company puts special emphasis on the safety and comfort of use of its products. Our equipment is used in many branches of economy, during work at heights, excavation works and in life-saving. We also offer elements of individual protective equipment for fall arresting – harnesses, safety energy absorbers, safety lanyards and structural fall arrest systems.

Combining the experience acquired over many years of manufacturing harnesses and equipment designed for industrial mountaineering with the commitment of our staff we decided to launch the PROVERTI brand, focused on manufacturing sport climbing harnesses and climbing equipment. We are dedicated to ensuring the highest quality standards of our equipment. At the same time we are trying to keep the prices of our products attractive.

The expertise and high skills of our staff and a professional laboratory ensure the highest quality standards. All our products have European Certificates, confirmed by foreign certifying bodies (i.e.: APAVE).

SALES DEPARTMENT

Protekt Grzegorz Laszkiewicz sp. z o.o.
Skromna 6
93-405 Łódź, POLAND

export@protekt.com.pl
+48 42 29 29 500

Agata Łukasiewicz
agata@protekt.com.pl
+48 42 29 29 510

Aleksandra Reszka
ola@protekt.com.pl
+48 42 29 29 503

Joanna Kraska
asia@protekt.com.pl
+48 42 29 29 508

Monika Tychaczka
monikat@protekt.com.pl
+48 42 29 29 506

REGISTERED ADDRESS

Protekt Grzegorz Laszkiewicz sp. z o.o.
Skromna 6
93-405 Łódź, POLAND
+48 42 29 29 500
Fax: +48 42 680 20 93



The content, photos and illustrations published on this catalogue are only for reference purposes. In order to get more detailed, up-to-date information about usage and technology, please contact our office. Protekt reserves the right to make printing mistakes without reprinting. In case of certain groups of products, there is a possibility of ordering the equipment in other configurations. The returns are not possible for products modified in accordance with Customer's requests and for custom-made products.

TABLE OF CONTENTS

HARNESSES FOR ARBORISTS	5
WARNING WAISTCOAT	9
CLIMBING SPIKES AND PARTS	10
EQUIPMENT FOR WORK POSITIONING	18
TOOL STRAPS	30
LIFTING AND LOWERING EQUIPMENT	34
PULLEYS	36
SNAP HOOKS	49
ROPE INSTALER	51
ROPES	52
PRUSIKS	56
ACCESSORIES	58
TRANSPORT PACK, BAG AND BASKETS	70
HAMMOCKS	76
ARBORIST'S TROLLEYS	78



TH-050 mX

Harness for arborists

EN 813, EN 358



SOFT BELT PAD

LATERAL WORK POSITIONING POINT

INTEGRATED SEAT

ADJUSTING BUCKLES

E ENHANCED ALL AUTOMATIC BUCKLES



TH-050mX sit harness for arborists equipped with cushioned waist belt and suspension seat, adjusting buckles, lateral work positioning point conform with EN 813. Quick release buckles. Comfortable putting on taking off. The TH-050mX sit harness is the basic equipment for working at heights, mainly on trees, poles, building constructions, etc.

Ref.:	Size	Weight
TH 150 21	M-XL	2500 g
	XXL	2600 g

TH 020

Harness for arborists

EN 358, EN 813



LATERAL WORK POSITIONING POINT



ADJUSTING BUCKLES

TH 020 sit harness for arborists equipped with cushioned waist belt and suspension seat, adjusting buckles, side catch clamps and suspension point conform with EN 813:2008. Aluminium adjusting buckles. No risk of accidental unbuckling. The TH 020 sit harness is the basic equipment for working at heights, mainly on trees, poles, building constructions, etc.

Ref.:	Size	Weight
TH 120 01	M-XL	1450 g
TH 120 02	XXL	1490 g

TH 030 mX

Harness for arborists

EN 358, EN 813



LATERAL WORK POSITIONING POINT



ADJUSTING BUCKLES

TH 030mX sit harness for arborists equipped with cushioned waist belt and suspension seat, adjusting buckles, side catch clamps and suspension point conform with EN 813:2008. Automatic stapling-adjustment buckles. Comfortable putting on taking off. The TH 030mX sit harness is the basic equipment for working at heights, mainly on trees, poles, building constructions, etc.

E ENHANCED ALL AUTOMATIC BUCKLES



Ref.:	Size	Weight
TH 130 21	M-XL	1780 g
	XXL	1820 g

P 71

Safety harness

EN 361, EN 358, EN 813



EN 361 DORSAL ATTACH POINT

EN 361 FRONT ATTACH POINT

EN 813 FRONT ATTACH POINT FOR SITTING POSITION



4 POINTS FRONT

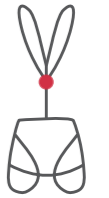

1 POINT BACK



EN 358 LATERAL WORK POSITIONING POINT

Ref.:	Size	Weight
AB 171 21	M-XL	1720 g
	XXL	1820 g

EN 361, EN 358, EN 813



Multifunctional safety harness with an ergonomic pad for the back and thighs and the hip belt, equipped with dorsal and front anchorage point and an anchorage point for work in suspended position. Adjustable shoulder and breast straps. Sit harness with side catch clamps.

Ref.:	Size	Weight
AB 190 21	M-XL	1950 g
	XXL	2030 g



High visibility vest with reflective tapes

Material:	85% polyamide, 15% cotton
Width of tape:	30 mm
Weight:	300 g
Waist size:	100 - 130 cm

COLORS AVAILABLE



Ref.:	Weight
VS 010	600 g



High visibility vest with reflective tapes

Material:	100% polyester
Width of tape:	30 mm
Weight:	300 g
Waist size:	100 - 130 cm

COLORS AVAILABLE

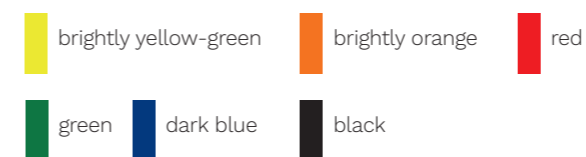

Ref.:	Weight
VS 011	300 g

IRON SPIKES



Spacer mesh for comfort and ventilation

Adjustment straps trimmed with soft softshell

Ergonomic cordura pads with sewn-in plastic stabilizing reinforcement

Smooth adjustment of the pads in the range of 33-48 cm from the foot level

Bottom fastener adjustment

Weight of the pair 3,16 kg

Length spike 6 cm



Transport backpack (color to choose)

Material:	steel, leather, poliester, softshell, ABS, cordura, mesh spacer
Weight:	3.16 kg

Color variants



DR 100 01



DR 100 02



DR 100 03



DR 100 04

CLIMBING SPIKES

DR 100 1 Replaceable upper textile straps



DR 100 2 Interchangeable bottom textile straps



DR 100 3 Removable pads covering the calf



DR 100 4 Safety covers spike



IRON SPIKES
Climbing irons

SCAN ME
▶ VIDEO



DR 1

Steel climbing spikes

DR 2

Steel climbing spikes

DR 2A

Aluminium climbing spikes

DR 3

Steel climbing spikes



Aluminium climbing spikes with adjustable height of the calf padding, the padding additionally equipped with metal plate bracing the leg, connected with a bow by an articulated joint. The set comprises of two replaceable spikes (short and long) made of hardened steel.

Steel climbing spikes with adjustable height of the soft calf padding. The set comprises of two replaceable spikes (short and long) made of hardened steel.

Aluminium climbing spikes with adjustable height of the soft calf padding. The set comprises of two replaceable spikes (short and long) made of hardened steel.

Steel climbing spikes with adjustable height of the calf padding (the padding additionally equipped with metal plate bracing the leg). The set comprises of two replaceable spikes (short and long) made of hardened steel.

Material:	steel, leather, felt
Weight:	3,75 kg
Ref.:	SP 501

Material:	steel, leather, felt
Weight:	3,80 kg
Ref.:	SP 505

Material:	aluminium, leather, felt
Weight:	2,56 kg
Ref.:	SP 502

Material:	steel, leather, felt
Weight:	3,85 kg
Ref.:	SP 506

DR 3A Aluminium climbing spikes



Aluminium climbing spikes with adjustable height of the calf padding, the padding additionally equipped with metal plate bracing the leg, connected with a bow by an articulated joint. The set comprises of two replaceable spikes (short and long) made of hardened steel.

Material: aluminium, leather, felt

Weight: 2,56 kg

Ref.:

SP 503

DR 4 Steel climbing spikes



Steel climbing spikes with soft calf padding. The set comprises of two replaceable spikes (short and long) made of hardened steel.











Material: steel, leather, felt

Weight: 4,80 kg

Ref.:

SP 504

Spare parts

	REF.	DR 1	DR 2	DR 2A	DR 3	DR 3A	DR 4
 SP 051 Short spike - set	SP051			•		•	
 SP 052 Long spike - set	SP052			•		•	
 SP 053 Short spike - set	SP053	•	•		•		•
 SP 054 Long spike - set	SP054	•	•		•		•
 SP 060 Lower strip ass-y	SP060	•	•	•	•	•	•
 SP 061 Long belt	SP061	•	•	•	•	•	•
 SP 062 Long belt bottom fastening	SP062	•	•	•	•	•	•
 SP 063 Short belt bottom fastening	SP063	•	•	•	•	•	•
 SP 064 Catch ring	SP064	•	•	•	•	•	•
 SP 065	SP065	•	•	•	•	•	•
 SP 070 Braced calf padding	SP070				•	•	•
 SP 071 Left leg padding	SP071	•	•	•			
 SP 072 Right leg padding	SP072	•	•	•			
 SP 073	SP073				•	•	•
 SP 080 Attachment	SP080		•	•	•	•	

PROT 10 Work positioning device

EN 358

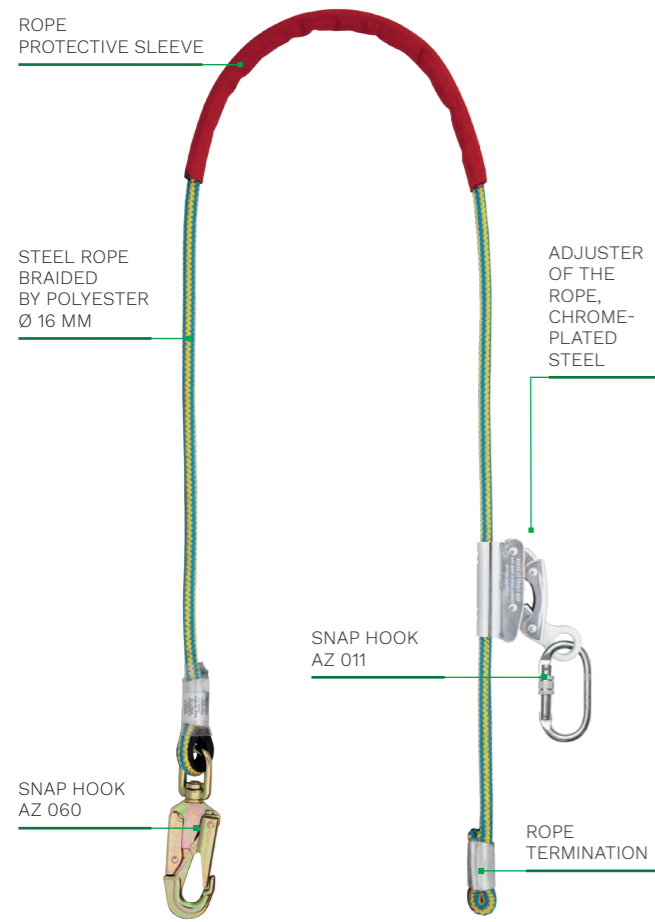

PROT 10 for work positioning conform with EN 358 with AZ 060 snap hook (opening: 21 mm) and AZ 011 (opening: 18 mm). PROT 10 has an adjustment mechanism made of chrome-plated steel.

Cut proof lanyard: polyester braided steel rope Ø 16 mm

Adjusting mechanism: stainless steel

Cable protective sleeve: coated fabric

Ref.:	Length
AF 150 200	2,0 m
AF 150 300	3,0 m
AF 150 400	4,0 m
AF 150 500	5,0 m

PROT 30 Work positioning device

EN 358

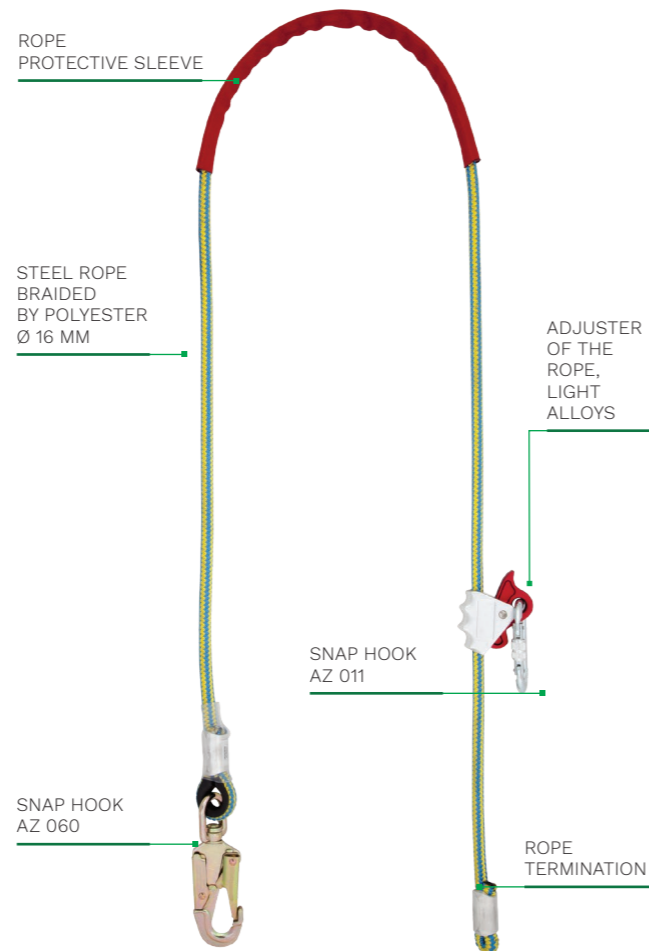

PROT 30 for work positioning conform with EN 358 with AZ 060 snap hook (opening: 21 mm) and AZ 011 (opening: 18 mm). PROT 30 has an adjustment mechanism made of light alloys.

Cut proof lanyard: polyester braided steel rope Ø 16 mm

Adjusting mechanism: stainless steel

Cable protective sleeve: coated fabric

Ref.:	Length
AF 160 200	2,0 m
AF 160 300	3,0 m
AF 160 400	4,0 m
AF 160 500	5,0 m

PROT 40 Work positioning device

EN 358

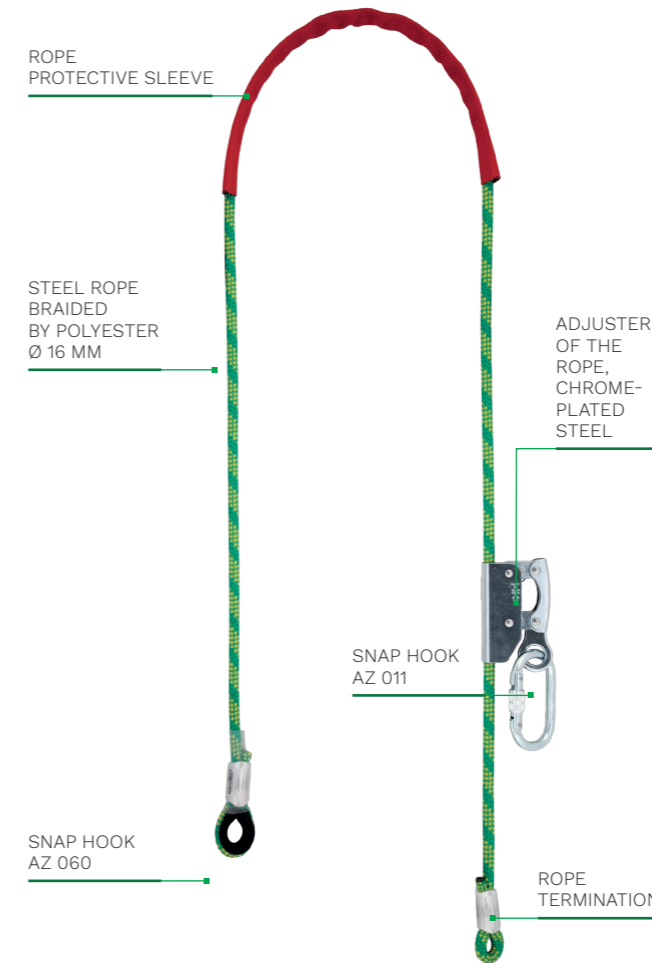

PROT 40 for work positioning conform with EN 358 with AZ 060 snap hook (opening: 21 mm) and AZ 011 (opening: 18 mm). PROT 40 has an adjustment mechanism made of chrome-plated steel.

Cut proof lanyard: polyester braided steel rope Ø 16 mm

Adjusting mechanism: light alloys

Cable protective sleeve: coated fabric

Ref.:	Length
AF 140 200	2,0 m
AF 140 300	3,0 m
AF 140 400	4,0 m
AF 140 500	5,0 m



PROT 70 Work positioning device

EN 358

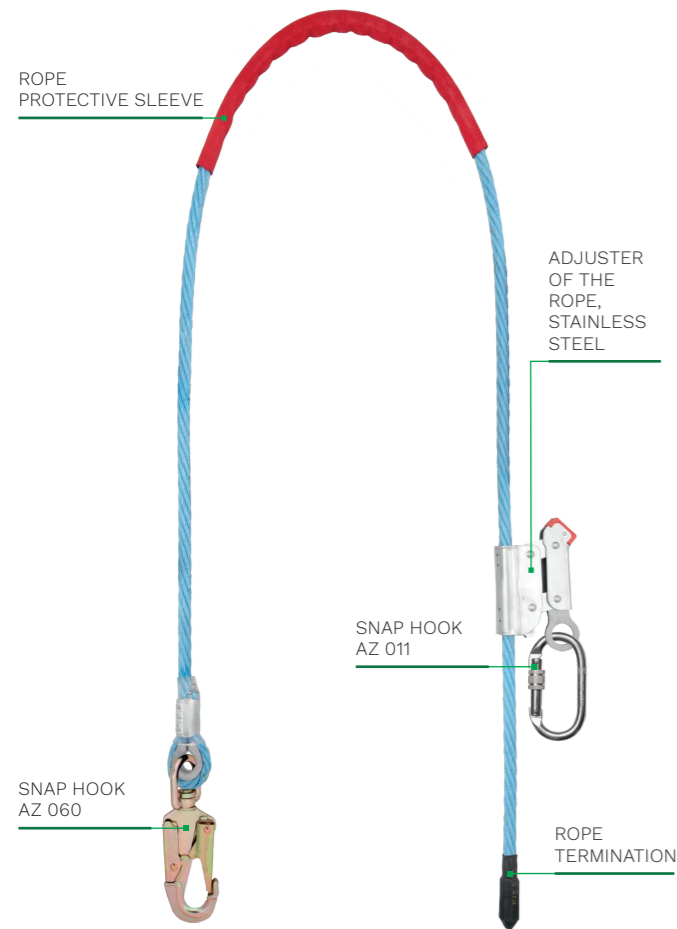

PROT 70 for work positioning conform with EN 358 with AZ 060 snap hook (opening: 21 mm) and AZ 011 (opening: 18 mm). PROT 70 is provided with an adjusting mechanism made of stainless steel. Special designed for work on the palms.

Cut proof lanyard: polypropylene braided steel rope Ø 16 mm

Adjusting mechanism: stainless steel

Cable protective sleeve: coated fabric

Ref.:	Length
AF 170 200	2,0 m
AF 170 300	3,0 m
AF 170 400	4,0 m
AF 170 500	5,0 m

TU 010 Work positioning device

EN 358

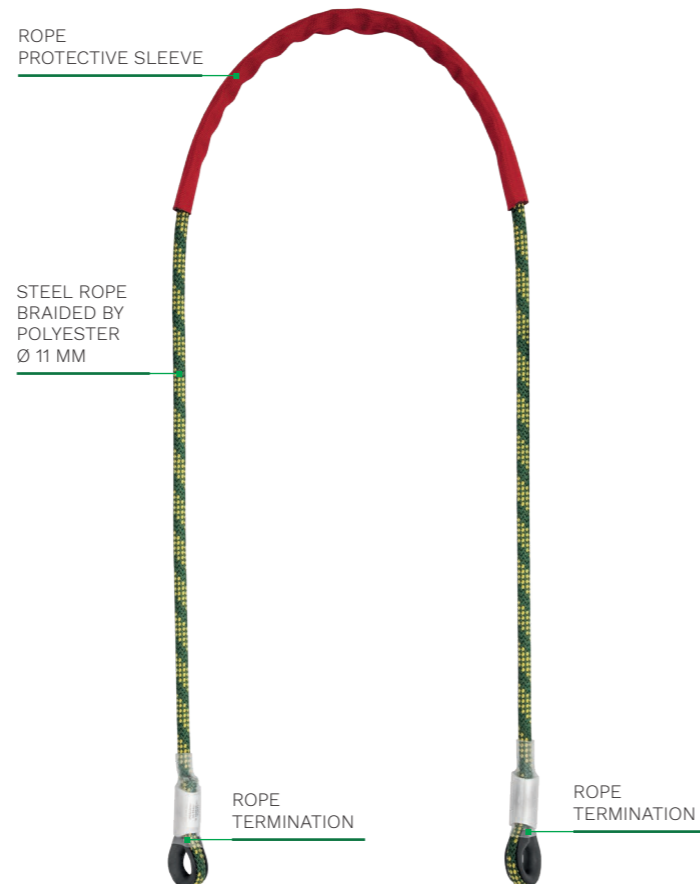

Cut proof lanyard: polyester braided steel rope Ø 11 mm

Cable end: strong crimped aluminium bits

Cable protective sleeve: coated fabric

Ref.:	Length
TU 010 200	2,0 m
TU 010 300	3,0 m
TU 010 400	4,0 m
TU 010 500	5,0 m

TU 011 Work positioning device

EN 358



Cut proof lanyard: polyester braided steel rope Ø 11 mm

Cable end: strong crimped aluminium bits, at one end aluminium snap hook AZ32DT with triple lock provided with a swivel shackle

Cable protective sleeve: coated fabric

Ref.:	Length
TU 011 200	2,0 m
TU 011 300	3,0 m
TU 011 400	4,0 m
TU 011 500	5,0 m



TU 500

Tree calbing strap

EN 358



Arborist girdle designed to provide elastic binding to improve the tree statics. They allow growth of the bound parts of trees and do not damage the trees. Made of triple 50mm wide polyester tape, terminated with forged steel buckles.

Lenghts: 90, 100, 120, 140 cm
available also in other lengths

Static strength: ≥ 25 kN

Ref.: Length

AZ 500 090 90 cm

AZ 500 100 100 cm

AZ 500 120 120 cm

TU 501

Tree calbing strap

EN 358



Arborist girdle designed to provide elastic binding to improve the tree statics. They allow growth of the bound parts of trees and do not damage the trees. Made of 45 mm wide polyester tape, terminated with forged steel D-ring buckles. Provided with tape for fixing on a tree trunk.

Lenghts: 40, 80, 120, 180 cm
available also in other lengths

Static strength: ≥ 25 kN

Ref.: Length

AZ 501 040 40 cm

AZ 501 080 80 cm

AZ 501 120 120 cm

TU 900 Cambium saver

EN 795 Typ B

CE



Work positioning lanyard TU 900 is terminated with rings of different diameters. Rigid flat tape reduces twisting. TU 900 ensures protection of tree branches and facilitates moving the cable at work position height.

Lenghts: 40, 60, 80, 100, 120, 140, 170 cm
available also in other lengths

Static strength: 25 kN

Weight: 280 g / 1m

Ref.: Length

TU 900 080 80 cm

TU 900 120 120 cm

AZ 600 Positioning webbing

EN 795 Typ B

CE

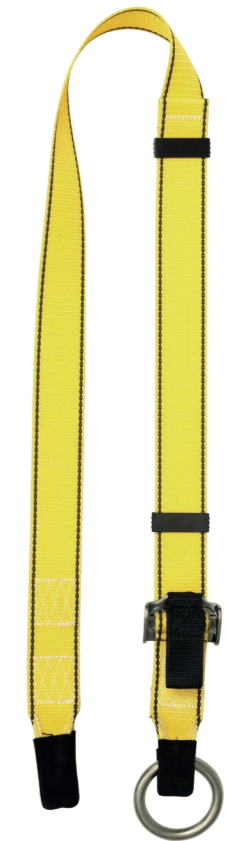

Portable anchoring point. One end is terminated with a metal ring. The webbing is provided with an adjustable buckle.

Material: textile webbing

Wide of tape: 40 mm

Lenght: 1 m ÷ 20 m

Static strength: 22 kN

Ref.: Length

AZ 600 015 1,5 m

AZ 600 003 3,0 m

AZ 600 006 6,0 m

AZ 600 010 10,0 m

AZ 900

Webbing sling

EN 354, EN 566, EN 795 Typ B

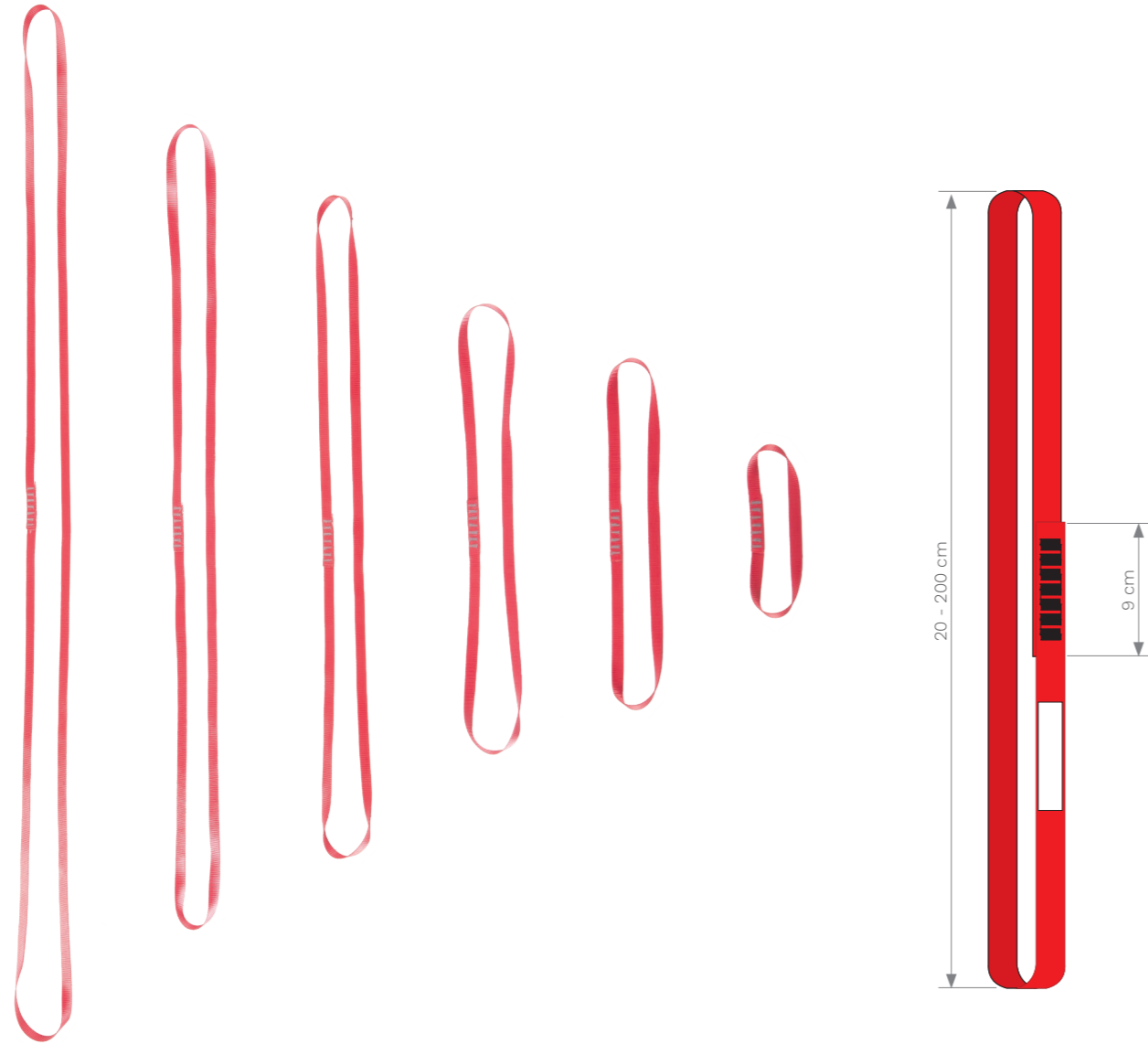

AZ 900 webbing sling is:

1. a component of the safety equipment arresting falls from heights including safety energy absorbers (e.g. ABM). Connecting and shock-absorbing element conform with EN 354,
2. a component of safety equipment arresting falls from heights used for connecting the connecting and shock-absorbing element to a fixed structure.

Material:	textile webbing
Width of webbing:	21 mm
Length:	30 cm ÷ 200 cm
Static strength:	22 KN
Ref.:	Length
AZ 900 030	30 cm
AZ 900 060	60 cm
AZ 900 080	80 cm
AZ 900 120	120 cm
AZ 900 150	150 cm
AZ 900 200	200 cm

AZ 900R

Webbing sling with a protective sleeve

EN 354, EN 566, EN 795 Typ B

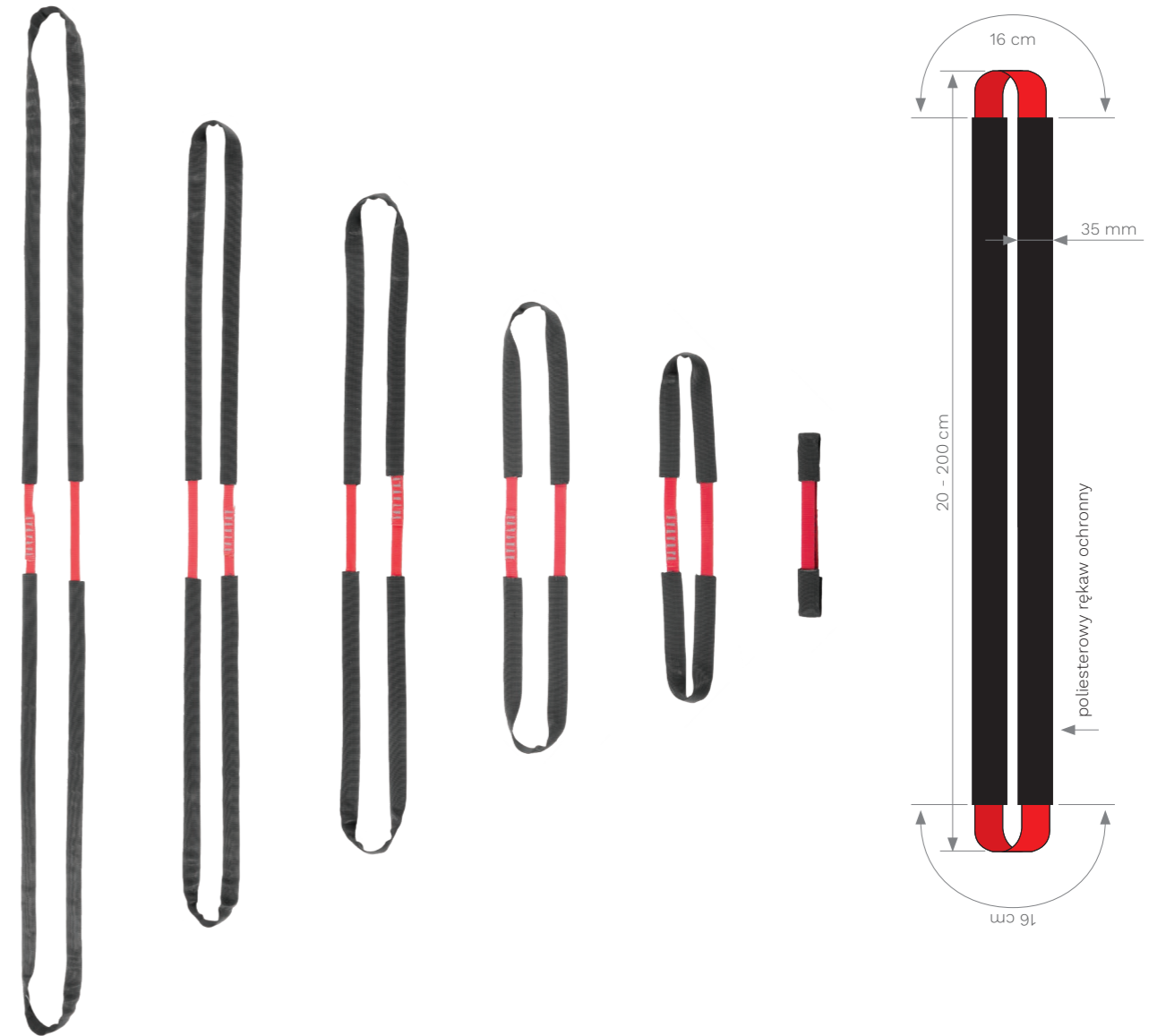

AZ 900R webbing sling is:

1. a component of the safety equipment arresting falls from heights including safety energy absorbers (e.g. ABM). Connecting and shock-absorbing element conform with EN 354,
2. a component of safety equipment arresting falls from heights used for connecting the connecting and shock-absorbing element to a fixed structure.

Material:	textile webbing
Width of webbing:	21 mm
Length:	30 cm ÷ 200 cm
Static strength:	22 KN
Ref.:	Length
AZ 900R 030	30 cm
AZ 900R 060	60 cm
AZ 900R 080	80 cm
AZ 900R 120	120 cm
AZ 900R 150	150 cm
AZ 900R 200	200 cm

AZ 910

Webbing sling

EN 354, EN 566, EN 795 CLASS B

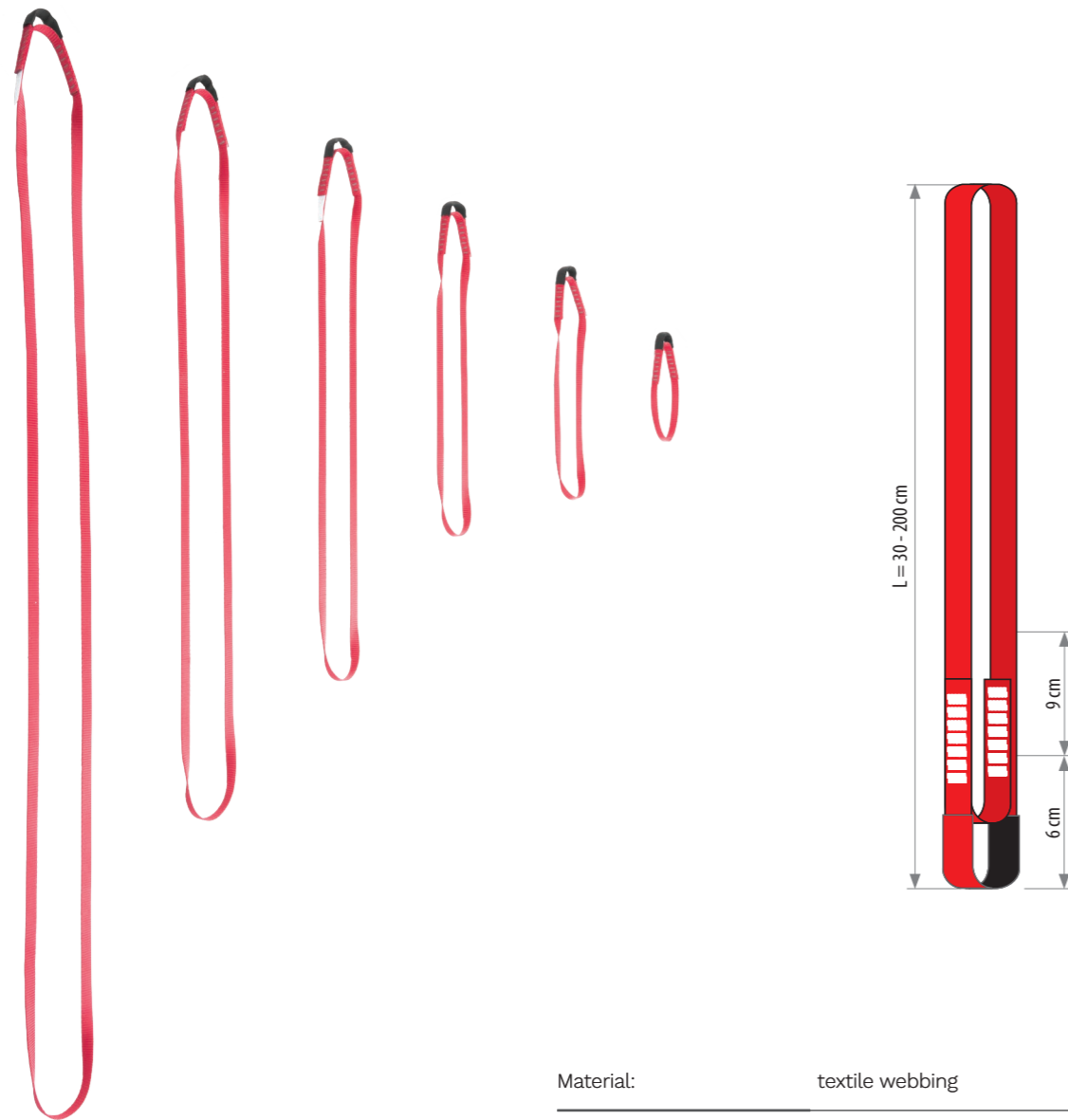

AZ 910 webbing sling is:

1. a component of fall protection equipment – when combined with an energy absorber (e.g. ABM) forms connecting and absorbing device complying with EN 354.
2. a component of safety equipment arresting falls from heights used for connecting the connecting and shock-absorbing element to a fixed structure.

Material:	textile webbing
Width of webbing:	20 mm
Length:	30 cm ÷ 200 cm
Static strength:	22 KN

Ref.:	Length
AZ 910 030	30 cm
AZ 910 060	60 cm
AZ 910 080	80 cm
AZ 910 120	120 cm
AZ 910 150	150 cm
AZ 910 200	200 cm

AZ 920

Webbing sling

EN 354, EN 566

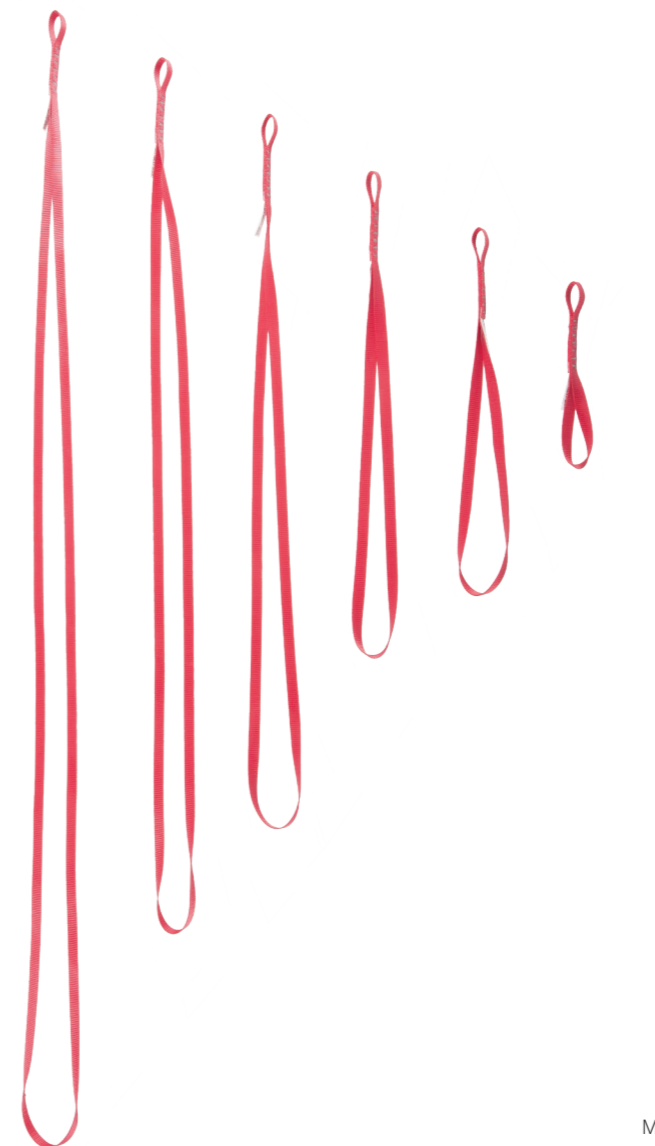

AZ 920 webbing sling is:

1. a component of the safety equipment arresting falls from heights including safety energy absorbers (e.g. ABM). Connecting and shock-absorbing element conform with EN 354,
2. a component of safety equipment arresting falls from heights used for connecting the connecting and shock-absorbing element to a fixed structure.

Material:	textile webbing
Width of webbing:	20 mm
Length:	20 cm ÷ 200 cm
Static strength:	22 KN

Ref.:	Length
AZ 920 020	20 cm
AZ 920 030	30 cm
AZ 920 060	60 cm
AZ 920 080	80 cm
AZ 920 120	120 cm
AZ 920 150	150 cm
AZ 920 200	200 cm

AZ 930

Webbing sling

EN 354, EN 566

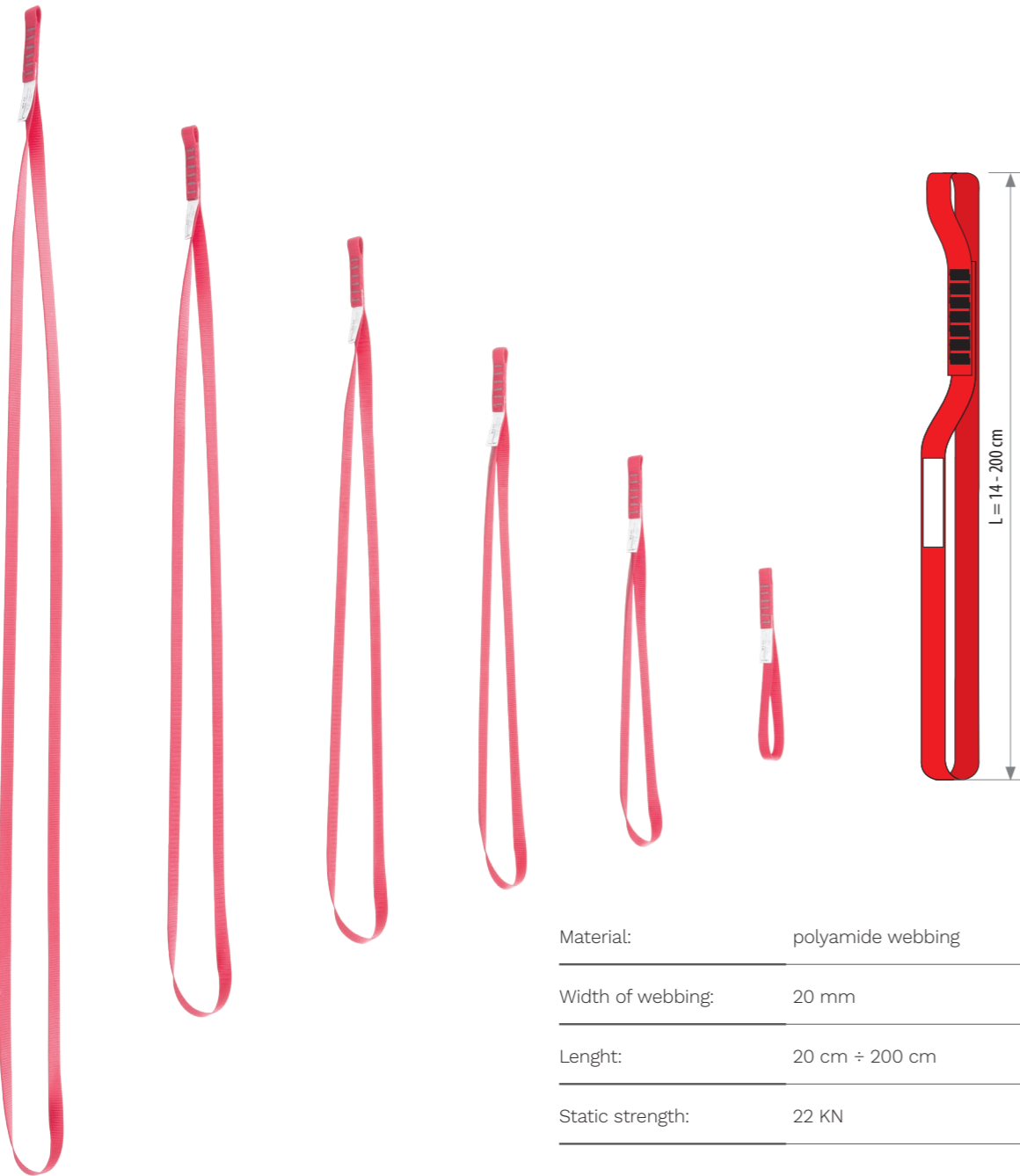

Material:	polyamide webbing
Width of webbing:	20 mm
Length:	20 cm ÷ 200 cm
Static strength:	22 KN

Ref.:	Length
AZ 930 014	14 cm
AZ 930 020	20 cm
AZ 930 030	30 cm
AZ 930 060	60 cm
AZ 930 080	80 cm
AZ 930 120	120 cm
AZ 930 150	150 cm
AZ 930 200	200 cm

AZ 930 webbing sling is:

1. component of fall protection equipment from a height - together with a safety shock absorber (e.g. ABM) - connecting and shock-absorbing subassembly according to EN 354,
2. component of fall protection equipment from a height, used to connect the connecting and shock-absorbing subassembly to a point of the permanent structure.



PROTEKT[®]
MANUFACTURER OF FALL PROTECTION EQUIPMENT

TOOL LANYARDS AND BAGS

7

GET BAG

- Transport sacks
- Transport backpacks
- Transport bags
- Tool and transport bucket
- Equipment covers bags
- Arborist baskets
- Transport sacks Dry Bag
- Tool lanyards
- Tool bags and belts

2024



SCAN THE QR CODE AND VIEW CATALOG

AY 051 Tool strap



Heavy duty tool strap for heavier tools such as drills, grinders and chainsaws. End loop to attach to harness. Terminating in a loop to attach tools.

Material:	polyester
Width of tape:	25 mm
Lenght:	1.3 m
Static strength:	5 kN
SWL:	50 kg
Safety factor:	7:1
Ref.:	AY 051

AY 052 Tool strap



Heavy duty tool strap for heavier tools such as drills, grinders and chainsaws. End loop to attach to harness. Terminating in a loop and metal ring to attach tools.

Material:	polyester
Width of tape:	25 mm
Lenght:	1.3 m
Static strength:	5 kN
SWL:	50 kg
Safety factor:	7:1
Ref.:	AY 052

AY 053 Tool strap



Heavy duty elasticated tool strap for heavier tools such as drills, grinders and chainsaws. End loop to attach to harness. Terminating in a loop and steel ring to attach tools.

Material:	polyester
Width of tape:	25 mm
Lenght:	1.3 m
Static strength:	5 kN
SWL:	50 kg
Safety factor:	7:1
Ref.:	AY 053

AY 054 Tool strap

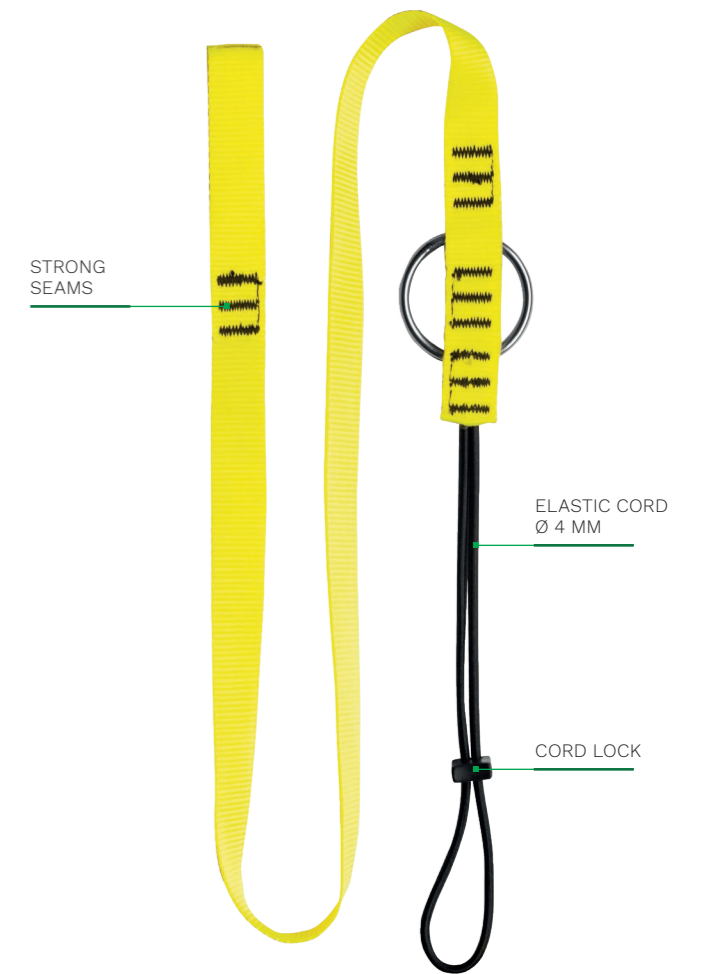

Heavy duty elasticated tool strap for heavier tools such as drills, grinders and chainsaws. End loop to attach to harness. Terminating in a loop and steel ring to attach tools. Tool strap have elastic cord with cord lock.

Material:	polyester
Width of tape:	25 mm
Lenght:	1.3 m
Static strength:	600 N
SWL:	8 kg
Safety factor:	7:1
Ref.:	AY 054

AY 055 Tool strap



Elastic tool strap – protection against dropping of tools, e.g. power screwdriver or chainsaw. Strong seams, handy inverted loop.

Material:	polyester
Webbing width:	25 mm
Length:	1.3 m
Static strength:	5 kN
Maximum load:	30 kg
Safety Factor:	7:1

Ref.:

AY 055

AY 132 Tool strap



Elastic tool strap with carabiner. Protection against dropping of tools, e.g. assembly wrenches.

Material	polyester
Width of tape:	64 cm
Lenght:	max. 125 cm
Static strength:	0,5 kg

Ref.:

AY 132

AY 135 Tool strap

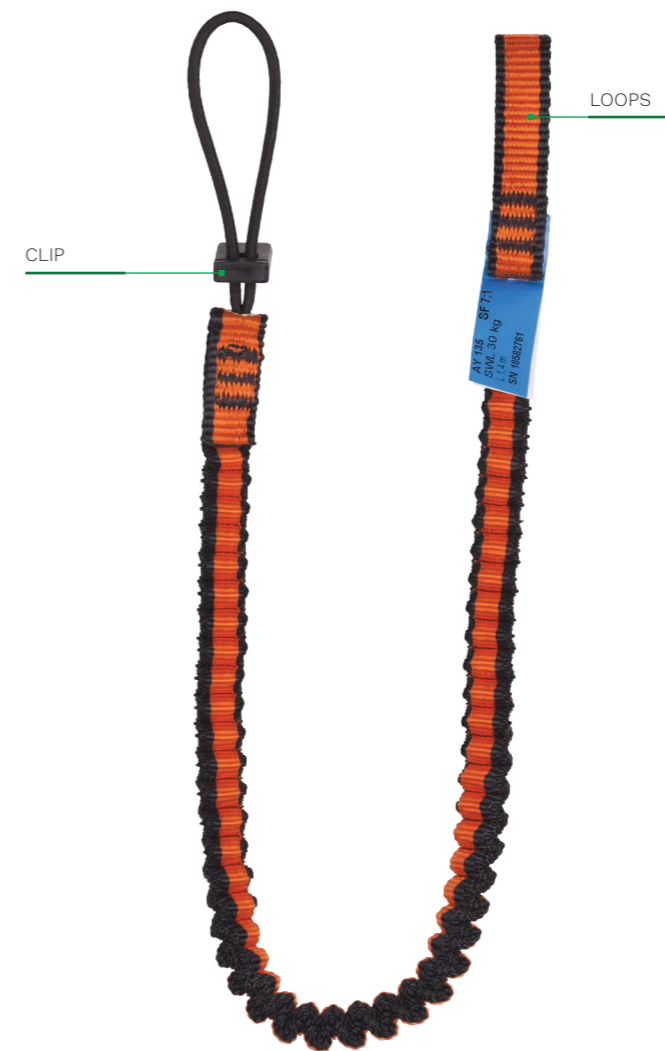

Elastic tool strap – protection against dropping of tools, e.g. assembly wrenches.

Material	polyester
Width of tape:	64 cm
Lenght:	max. 125 cm
Static strength:	0,5 kg

Ref.:

AY 135

AY 153 Tool strap



Elastic tool lanyard with handy inverted loop. Protection against dropping of tools, e.g. assembly wrenches.

Material	polyester
Width of tape:	64 cm
Lenght:	max. 125 cm
Static strength:	15 kg

Ref.:

AY 153

TU 200 Lowering Device

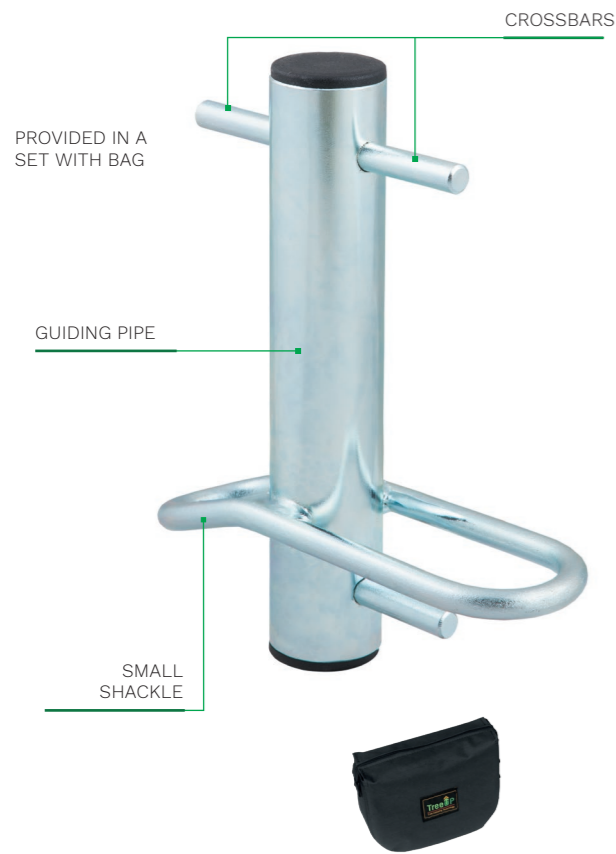

PORT-A-WRAP TU 200 – a device designed for arborists. Used mainly for sectional tree felling. Used for controlled lowering of material. By correct weaving the cable through the device, branches or parts (sections) of the trunk can be safely lowered to the ground. Sectional tree felling without damaging the bark of the tree trunk.

Rope diameter:	ø 10 - 14 mm
Dimensions:	265 x 230 x 75 mm
Weight:	1,92 kg
Max. Working load - WLL:	10 kN
Breaking force - MBS:	50 kN
Material:	galvanized steel
Ref.:	
TU 200	

TU 201 Lowering Device



PORT-A-WRAP TU 201 – a device designed for arborists. Used mainly for sectional tree felling. Used for controlled lowering of material. By correct weaving the cable through the device, branches or parts (sections) of the trunk can be safely lowered to the ground. Sectional tree felling without damaging the bark of the tree trunk.

Rope diameter:	ø 10 - 20 mm
Dimensions:	260 x 282 x 108 mm
Weight:	2,32 kg
Max. Working load - WLL:	10 kN
Breaking force - MBS:	50 kN
Material:	stainless steel
Ref.:	
TU 201	

TU 100 Lowering Device



PORT-A-WRAP TU 100 – a device designed for arborists. Used mainly for sectional tree felling. Used for controlled lowering of material. By correct weaving the cable through the device, branches or parts (sections) of the trunk can be safely lowered to the ground.

Rope diameter:	ø 10 - 14 mm
Dimensions:	370 x 385 x 300 mm
Weight:	7,30 kg
Max. Working load - WLL:	10 kN
Breaking force - MBS:	50 kN
Material:	galvanized steel rostfreier Stahl
Ref.:	
TU 100	

TU 110 Lowering Device

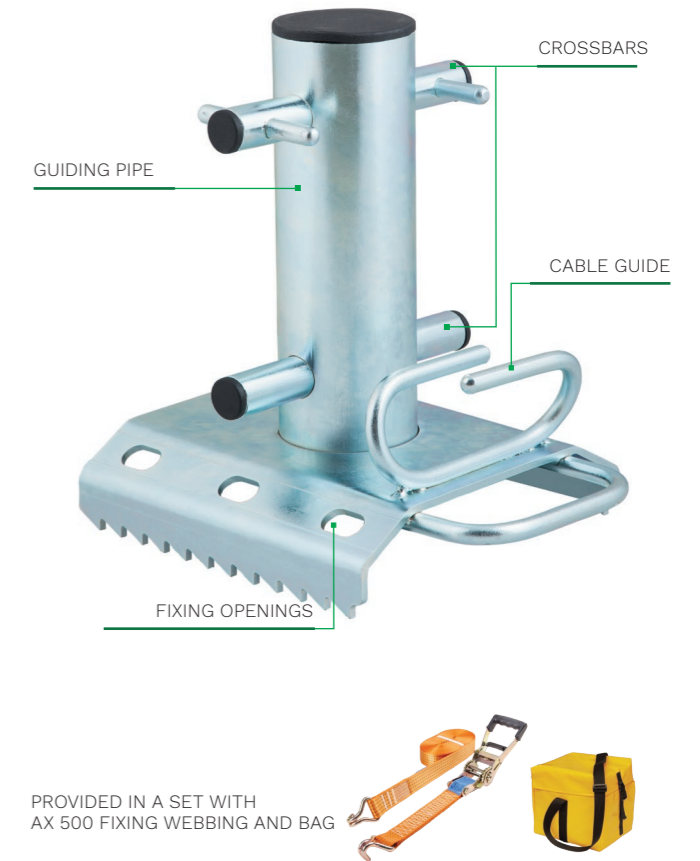

PORT-A-WRAP TU 110 – a device designed for arborists. Used mainly for sectional tree felling. Used for controlled lowering of material. By correct weaving the cable through the device, branches or parts (sections) of the trunk can be safely lowered to the ground. Sectional tree felling without damaging the bark of the tree trunk.

Rope diameter:	ø 10 - 14 mm
Dimensions:	335 x 300 x 250 mm
Weight:	6,45 kg
Max. Working load - WLL:	10 kN
Breaking force - MBS:	50 kN
Material:	galvanized steel
Ref.:	
TU 110	

TU 400 Small pulley with full axle and pin locker

EN 12278:2007



COLORS AVAILABLE



Dimensions:	176 x 96 x 88 mm
MBS:	100 kN
WLL:	20 kN
Safety factor:	5:1
Max. Cable diameter:	<18 mm
Ø of port in the axis:	18 mm
Weight:	1,38 kg
Material:	body - forged aluminium main pivot - stainless steel rolls - aluminium

Ref.:

TU 400

TU 401 Small pulley with full axle and screw locker

EN 12278:2007



COLORS AVAILABLE



Dimensions:	176 x 96 x 88 mm
MBS:	100 kN
WLL:	20 kN
Safety factor:	5:1
Max. Cable diameter:	<18 mm
Ø of port in the axis:	18 mm
Weight:	1,38 kg
Material:	body - forged aluminium main pivot - stainless steel rolls - aluminium

Ref.:

TU 401

TU 402 Small pulley with a hollow axle and pin locker

EN 12278:2007



COLORS AVAILABLE



Dimensions:	176 x 96 x 88 mm
MBS:	100 kN
WLL:	20 kN
Safety factor:	5:1
Max. Cable diameter:	<18 mm
Weight:	1,40 kg
Material:	body - forged aluminium main pivot - stainless steel rolls - aluminium

Ref.:

TU 402

TU 403 Small pulley with a hollow axle and screw locker

EN 12278:2007



COLORS AVAILABLE



Dimensions:	176 x 96 x 81 mm
MBS:	100 kN
WLL:	20 kN
Safety factor:	5:1
Max. Cable diameter:	<18 mm
Weight:	1,40 kg
Material:	body - forged aluminium main pivot - stainless steel rolls - aluminium

Ref.:

TU 403

TU 404 Large pulley with full axle and pin locker

EN 12278:2007

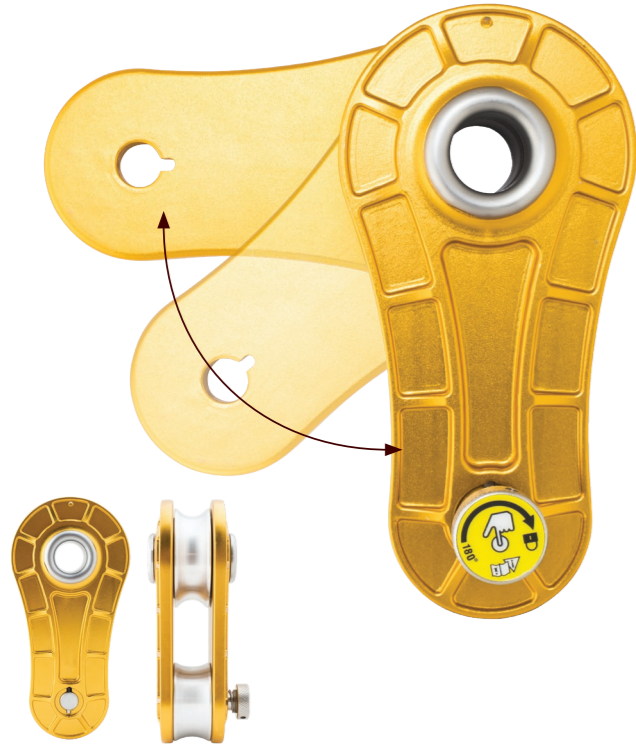

COLORS AVAILABLE



Dimensions:	238 x 85 x 115 mm
MBS:	125 kN
WLL:	25 kN
Safety factor:	5:1
Max. Cable diameter:	<30 mm
Ø of port in the axis:	30 mm
Weight:	2,30 kg
Material:	body - forged aluminium main pivot - stainless steel rolls - aluminium

Ref.:

TU 404

TU 405 Large pulley with full axle and screw locker

EN 12278:2007

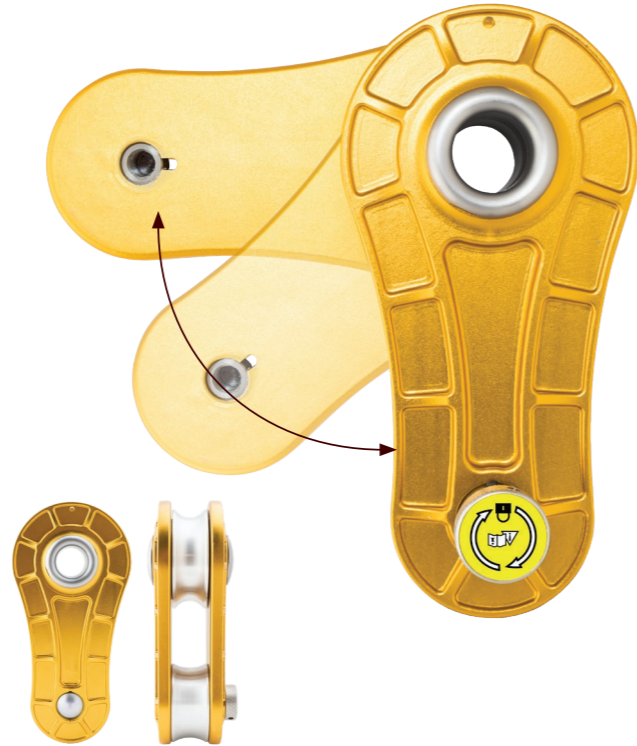

COLORS AVAILABLE



Dimensions:	238 x 85 x 115 mm
MBS:	100 kN
WLL:	20 kN
Safety factor:	5:1
Max. Cable diameter:	<30 mm
Ø of port in the axis:	30 mm
Weight:	2,3 kg
Material:	body - forged aluminium main pivot - stainless steel rolls - aluminium

Ref.:

TU 405

TU 406 Large pulley with a hollow axle and pin locker

EN 12278:2007



COLORS AVAILABLE



Dimensions:	238 x 85 x 115 mm
MBS:	125 kN
WLL:	25 kN
Safety factor:	5:1
Max. Cable diameter:	<30
Weight:	2,5 kg
Material:	body - forged aluminium main pivot - stainless steel rolls - aluminium

Ref.:

TU 406

TU 407 Large pulley with a hollow axle and screw locker

EN 12278:2007



COLORS AVAILABLE



Dimensions:	238 x 85 x 115 mm
MBS:	100 kN
WLL:	20 kN
Safety factor:	5:1
Max. Cable diameter:	<30
Weight:	2,5 kg
Material:	body - forged aluminium main pivot - stainless steel rolls - aluminium

Ref.:

TU 407

TU 410

Pulley block



TU 411
UPPER PULLEY



TU 412
LOWER PULLEY



CLEAT: LOCKING THE ROPE DURING LIFTING

TU 411
UPPER PULLEY

TU 412
LOWER PULLEY

21 mm

min. 700 mm

The TU 410 pulley block is design to lift the material and loads. It will be mainly used in sectional tree felling. It is used for controlled lowering of the material. By correct weaving the rope through the device, branches or parts (sections) of the trunk can be safely lowered. It is an ideal set for use in hardly accessible, confined spaces in the crowns of trees.

Special remark:

Since the gear ratio is 4:1 the ropes ordered should have 4x the length that would normally be ordered for the given use. For instance, there are 15 m of operating rope length in a 60 m long rope.

Dimensions:	250 x 198 mm - TU411 198 x 198 mm - TU412
Weight:	1822 g - TU411 1508 g - TU412
Gear ratio (of the set):	4:1
Breaking force - MBS:	50 kN
Max. Working load - WLL:	10 kN
Rope diameter:	ø 8 - 12 mm (textile rope only)

Ref.:

TU 410 (SET)

TU 411

TU 412

TU 413

Pulley block

Machinery Directive: 2006/42/EEC

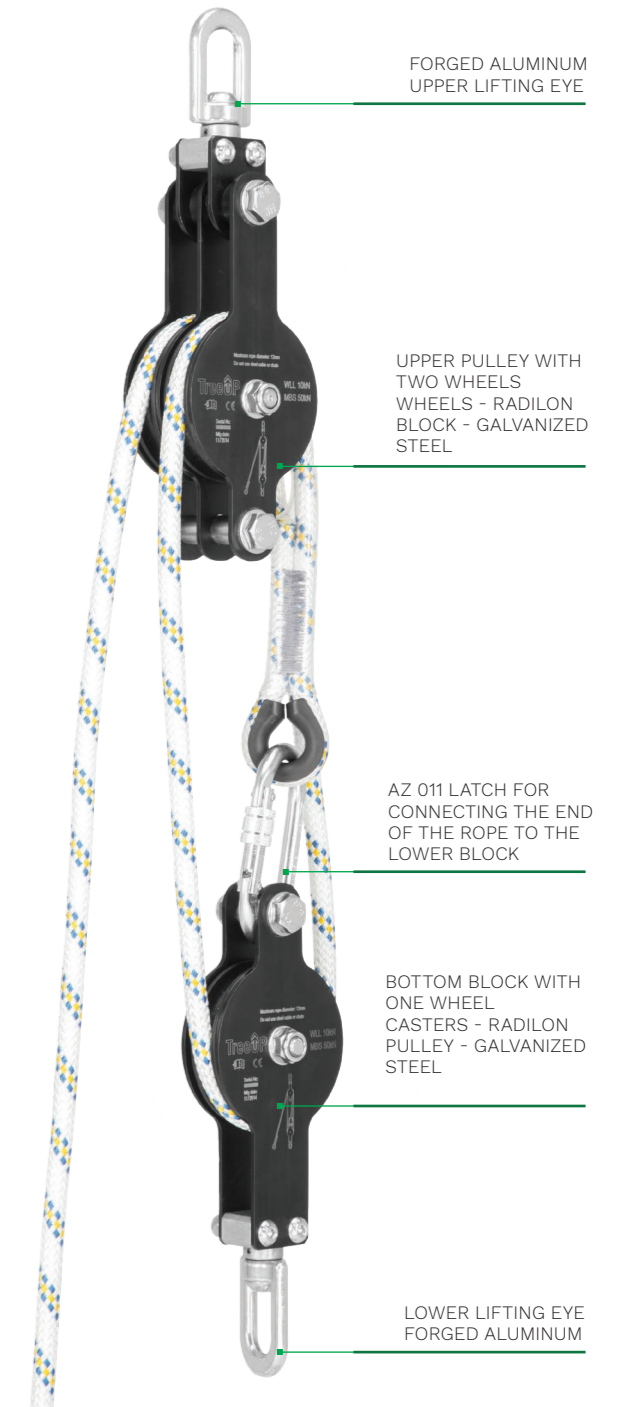

FORGED ALUMINUM
UPPER LIFTING EYE

UPPER PULLEY WITH
TWO WHEELS
WHEELS - RADILON
BLOCK - GALVANIZED
STEEL

AZ 011 LATCH FOR
CONNECTING THE END
OF THE ROPE TO THE
LOWER BLOCK

BOTTOM BLOCK WITH
ONE WHEEL
CASTERS - RADILON
PULLEY - GALVANIZED
STEEL

LOWER LIFTING EYE
FORGED ALUMINUM

INTENDED USE

TU 413 pulley block may be used in arboriculture (sectional tree felling) and transporting loads. The device is designed for lifting and lowering loads. It is not designed for use as personal fall arresting equipment.

DESIGN

The TU 413 pulley block set consists of the following elements:

- upper rope pulley with two wheels
- lower rope pulley with one wheel
- connector for catching end of the working rope with lower pulley
- working rope

APPLIED MATERIALS

Both (upper and lower) pulleys consist of wheels made of plastic - radilon (set on ball bearings, enabling free wheel motion under load) connected to galvanized steel plates.

The axles and connectors (bolts, nuts, washers) are made of galvanized steel. Each pulley is provided with swivel eye made of aluminum alloy. The eye on the upper pulley may be additionally rotated in relation to the block body.

Rope diameter:	ø 12 mm
Gear ratio (of the set):	3:1
Breaking force - MBS:	50 kN
Max. Working load - WLL:	10 kN
Safety factor:	5:1
Weight:	2,47 kg

Ref.: rope length

TU 413 (SET)	-
TU 413 10	10 m
TU 413 20	20 m
TU 413 30	30 m
TU 413 40	40 m
TU 413 50	50 m

TU 415 Pulley with hook 1000 kg



Material:	galvanized steel, radilon, stainless steel, cast iron casting
Weight:	1,14 kg
Dimensions:	330 x 130x 56 mm
Max. Working load:	max. 1000 kg
Wire rope diameter:	do 6,3 mm
Textile rope diameter:	8,0 - 12,0 mm
Safety factor:	3:1
Ratio:	1:2
WLL:	10 kN
MBS:	40 kN

Ref.:
TU 415

TU 416 Pulley with hook 2000 kg

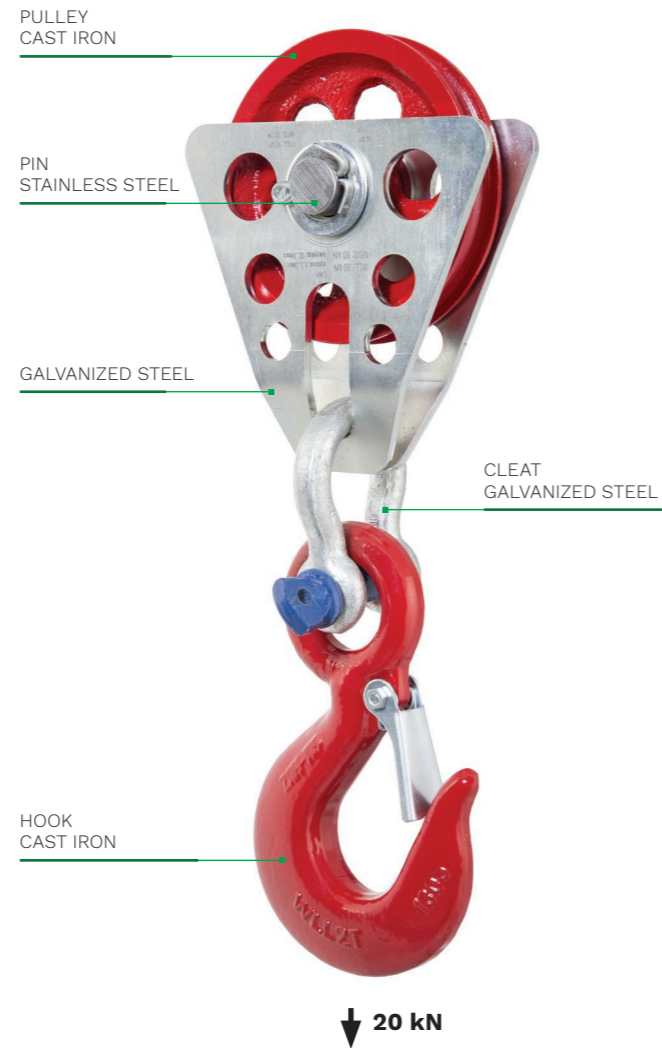

Material:	galvanized steel, cast iron casting, stainless steel
Weight:	2,15 kg
Dimensions:	330 x 130x 56 mm
Max. Working load:	max. 2000 kg
Wire rope diameter:	6,3 - 8,0 mm
Textile rope diameter:	12,0 - 14,0 mm
Safety factor:	3:1
Ratio:	1:2
WLL:	20 kN
MBS:	60 kN

Ref.:
TU 416

PL 101 Pulley

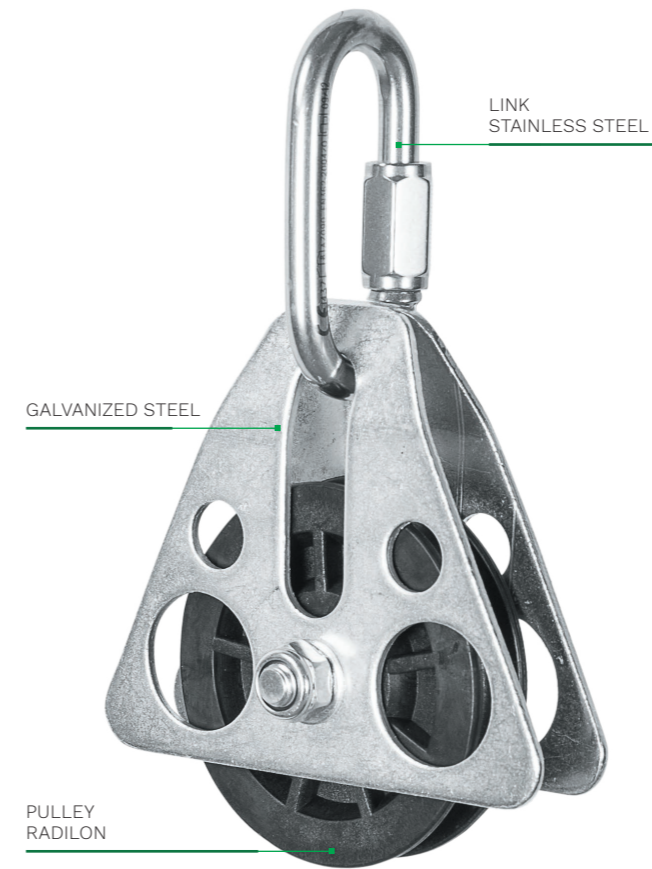

Dimensions:	133 x 56 x 128 mm
Weight:	450 g
Max. Working load:	500 kg
Breaking force:	30 kN
Safety factor:	1:5
Rope diameter:	6 mm - 12 mm

Ref.:
WP 011



TU 420

Arborist mini Pulley

ENHANCED

EN 12278

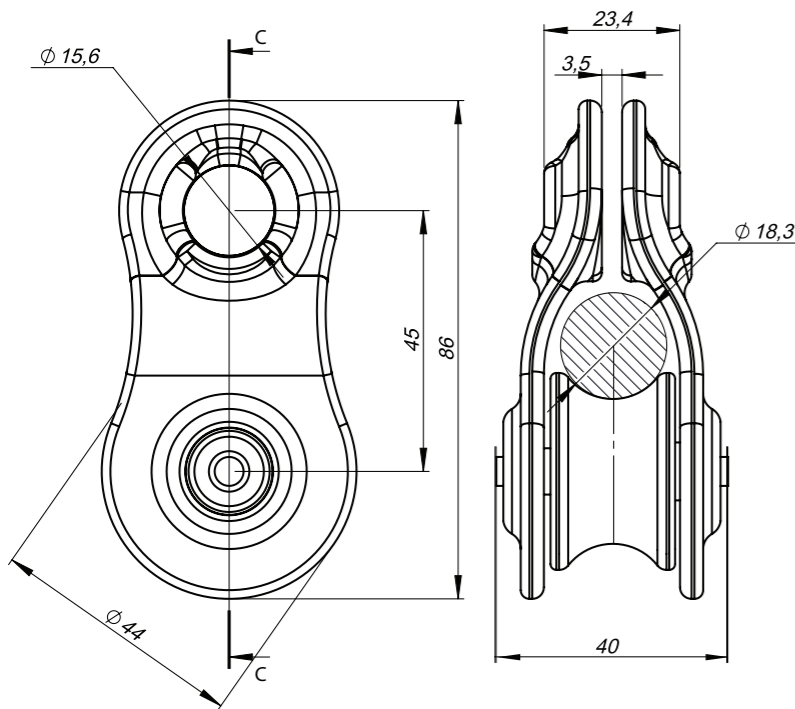

Dimensions:	80 x 44 x 37 mm
Weight:	105 g
Material:	aluminum alloy
Cover:	coloured anode
MBS:	25 kN
WLL:	5 kN
Safety factor:	5:1
Max. Diameter of rope:	<math><13,5\text{ mm}</math>

COLORS AVAILABLE



Ref.:
TU 420

TU 421

Triple arborist pulley

ENHANCED

EN 12278

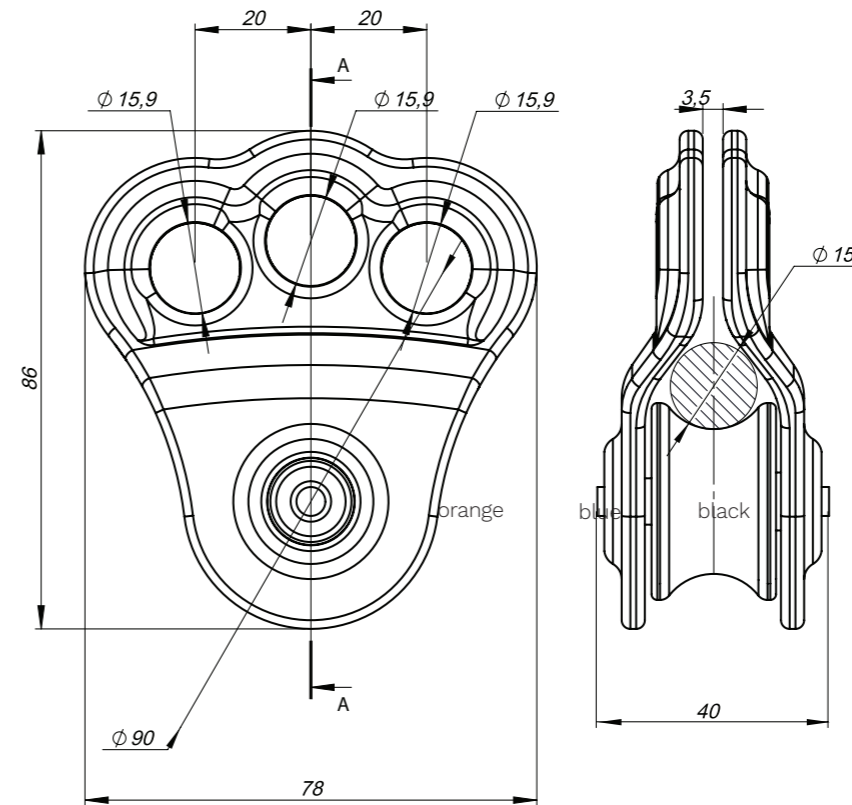

Dimensions:	90 x 70 x 37 mm
Weight:	160 g
Material:	aluminum alloy
Cover:	coloured anode
MBS:	25 kN
WLL:	5 kN
Safety factor:	5:1
Max. Diameter of rope:	<math><13,5\text{ mm}</math>

COLORS AVAILABLE



Ref.:
TU 421

TU 430

Round pulley

EN 12278

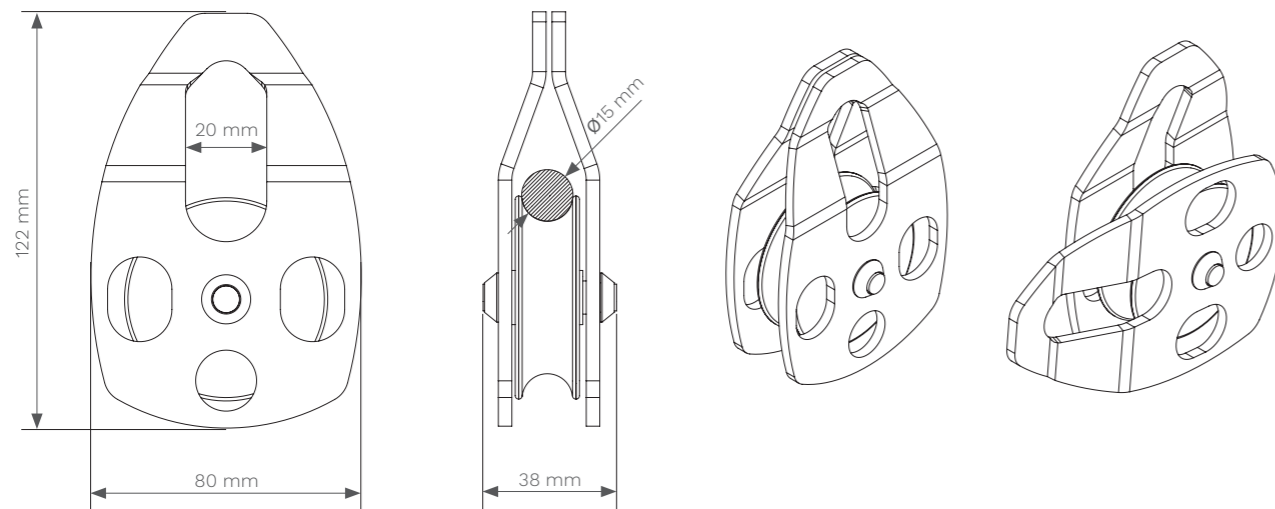

COLORS AVAILABLE



Ref.:

TU 430

Dimensions:	122 x 80 x 38 mm
Weight:	257 g
Material:	aluminum alloy
Cover:	coloured anode
MBS:	30 kN
WLL:	6 kN
Safety factor:	5:1
Max. Diameter of rope:	<15 mm

TU 431

Double pulley

EN 12278

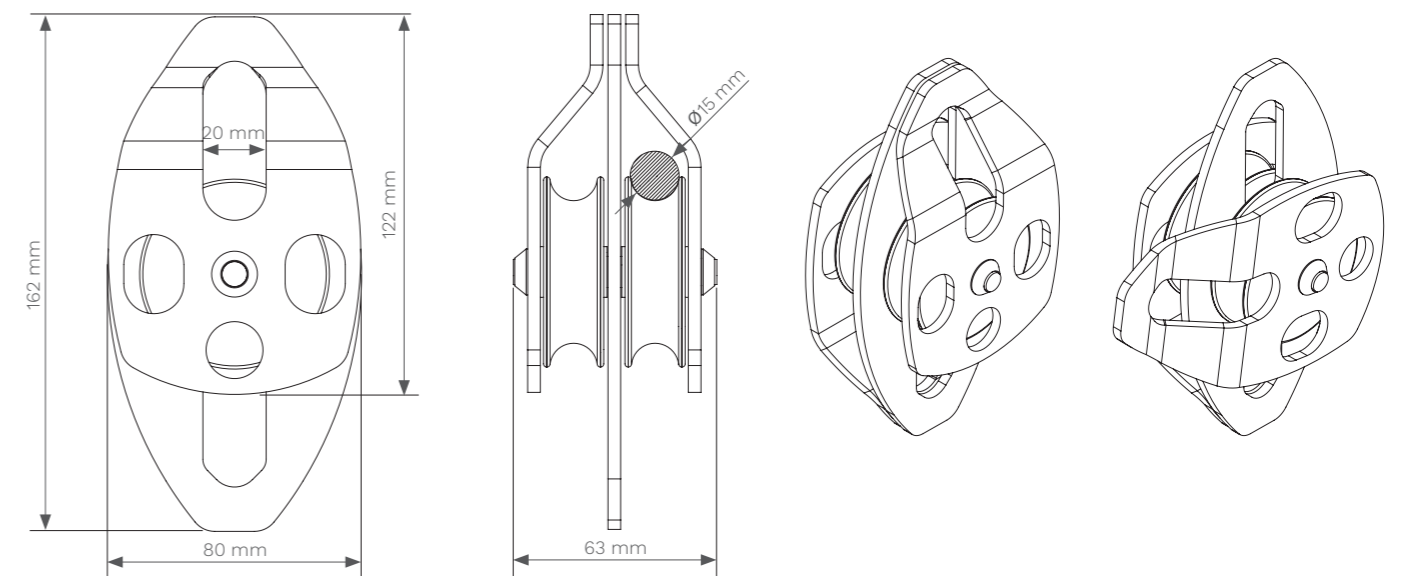

COLORS AVAILABLE



Ref.:

TU 431

Dimensions:	162 x 80 x 63 mm
Weight:	470 g
Material:	aluminum alloy
Cover:	coloured anode
MBS:	30 kN
WLL:	6 kN
Safety factor:	5:1
Max. Diameter of rope:	<15 mm

TU 440

Pulley

EN 12278

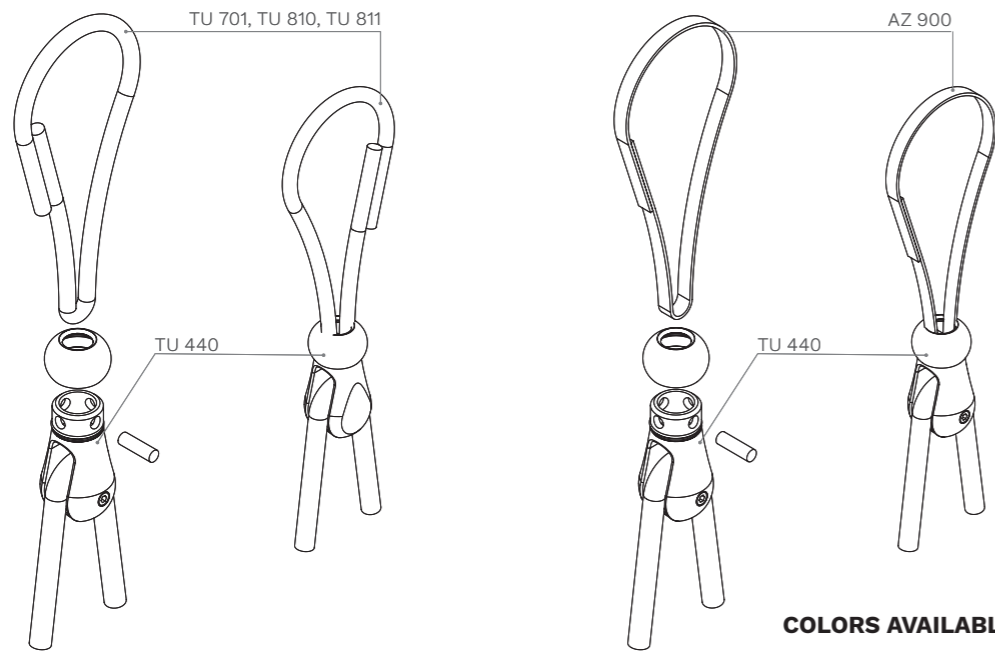







COLORS AVAILABLE



Ref.:
TU 440

Dimensions:	85 x 40 x 39 mm
MBS:	25 kN
WLL:	25 kN
max.load:	500 kg (5 kN)
Weight:	153 g
Max. diameter of rope:	Ø 10 mm
Max. width of tape:	21 mm
Material:	aluminium, hardened steel

Snap hooks

REF.	Opening	Material	Weight	Dimensions	Min. Static strength	Standard	
 AZ 011 Separable snap hook with locking nut (double lock)	AZ011	18 mm	galvanized steel	170 g	108 x 60 mm	20 kN	EN 362
 AZ 011T Separable snap hook with "twist lock" (double lock)	AZ011T	18 mm	galvanized steel	170 g	108 x 60 mm	20 kN	EN 362
 AZ 014DT Separable snap hook with "double twist lock" (double lock)	AZ014DT	22 mm	aluminium	80 g	115 x 74 mm	20 kN	EN 362
 AZ 017 Separable snap hook with locking nut (double lock)	AZ017	25 mm	galvanized steel	200 g	113 x 71 mm	20 kN	EN 362
 AZ 017T Separable snap hook with "twist lock" (double lock)	AZ017T	25 mm	galvanized steel	200 g	113 x 71 mm	20 kN	EN 362
 AZ 017DT Separable snap hook with "twist lock" (double lock)	AZ017DT	25 mm	galvanized steel	200 g	113 x 71 mm	20 kN	EN 362
 AZ 019T Separable snap hook with "twist lock" (double lock)	AZ019T	27 mm	aluminium	80 g	119 x 75 mm	20 kN	EN 362



DT 200, DT 201, DT 202

Rope instaler

ENHANCED

EN 62193, EN 60832-1



Voltage rated 110-440 kV

The telescopic poles were tested by the High Voltage Laboratory of the Energy Institute in Warsaw, accredited by the Polish Research Center and Accreditation.

Each poles ends with an M10 thread.



Ref. no.:	DT 203	DT 200	DT 201	DT 202
Weight	4,68 kg	3,84 kg	2,76 kg	1,92 kg
Maximum length	9296 mm	8076 mm	6398 mm	4946 mm
Minimum length	2180,5 mm	2060,5 mm	1851,5 mm	1850 mm
Rated voltage up to	440 kV	440 kV	220 kV	110 kV
Ilość członów	5	5	4	3
Tensile strength	1323 N	1323 N	1323 N	1323 N
Torsional strength	12,5 Nm	12,5 Nm	12,5 Nm	12,5 Nm
Mechanical bending strength	434 Nm	365 Nm	271 Nm	190 Nm

Locking of individual sections of the rod is done in any of their positions. Works with hooks and installers for hanging the working cable, acoustic sensors and other devices that interact with the UDI head. It is possible to use an extension cap with the UDI head (DT 900) and DT 800. The rod does not include the UDI head - DT 800.

TU 129, TU 130

Working rope

EN 1891 Class A



Diameter [mm]:	12	13,5
Type of rope:	A	A
Static tenacity:	≥ 22 kN	≥ 22 kN
Breaking force	29,3 kN	32,8 kN
Relative mass of sheat (%):	57,8	67
Relative sheat of mass (%):	42,2	33
Number of falls - facto 1:	15	40
Elongation (50 – 150 kg) (%):	2 %	3,9%
Max. impact force (kN) 0,3:	5,6 kN	4,9 kN
Sheat slippage (mm):	0,6 %	0,3%
Weight:	102 g/m	130 g/m
Knotability:	K = 0,9	K=1,11
EC Certyfikate:	Nr 0082/1814/160/11/18/0777	Nr 0082/1814/160/07/13/028
Material Core:	poliamid	poliamid
Material Braid:	poliester	poliester
Ref.	PesPa 12-K-16	PesPa 13,5-K-16

Rope intended mainly for tree nursing work. Large diameter assures higher resistance to wear and tear. Adequate elasticity for working with pulleys, snap hooks and other equipment. Red-white colour assures good visibility.

TU 131

Working rope

EN 1891 Class A



Rope intended mainly for tree nursing work. Available in five diameters: 10, 10.5, 11, 11.5 and 12 mm. It is a core rope with braid with low stretchability. The rope is an item of individual protective equipment for arresting falls from heights.

Rope diameter:	Ø 10 mm	Ø 10,5 mm	Ø 11 mm	Ø 12 mm
Ref.	Pa 100-10-K-24	Pa 100-105-K-24	Pa 100-11-K-24	Pa 100-12-K-24
Weight:	68 g/m	72 g/m	76 g/m	98 g/m
Relative elongation:	3,4 %	2,9%	3,3 %	3,9 %
Braid slip:	0,9 %	0,5%	1%	0,6 %
Min. Static strength:	22 kN	22 kN	22 kN	22 kN
Breaking force:	29,10 kN	29,8 kN	30,60 kN	32,10 kN
Material:	Polyamide	Polyamide	Polyamide	Polyamide

TU 132 Rope for loads



The rope is made entirely of high-strength polyester. Made of 12 fibers in a uniform braid structure. The rope is intended only for transporting loads. Bright color ensures good visibility. It is perfect as a rope for hydrants or pulleys.

Rope diameter:	Ø 16 mm	Ø 18 mm
Strength:	36 kN	45 kN
Material:	polyester	polyester
Ref.	TU 132 16	TU 132 18

TU 327



Material:	blue anodized aluminum
Diameters:	TU 327 020 - Ø 24,00 mm TU 327 018 - Ø 22,00 mm TU 327 016 - Ø 18,00 mm TU 327 014 - Ø 16,00 mm TU 327 012 - Ø 14,00 mm TU 327 010 - Ø 12,00 mm TU 327 008 - Ø 9,00 mm TU 327 006 - Ø 6,00 mm

TU 135 Prusik rope



Rope diameter:	Ø 10 mm
Strength:	17 kN
Material:	aramid, polyester
Ref.	TU 135

A set of splicing awls



Ref.:	TU 327
-------	--------

TU 143 Whoopie Slings



Rope diameter:	Ø 20 mm
Material:	polyester

Ref.	Diameter:	Length:
TU 143 150	Ø 20 mm	95 - 150 cm
TU 143 250	Ø 20 mm	95 - 250 cm
TU 143 300	Ø 20 mm	95 - 300 cm
TU 143 350	Ø 20 mm	95 - 350 cm

TU 145



TU 144 Loopie Slings



Rope diameter:	Ø 20 mm
Material:	polyester

Ref.	Diameter:	Length:
TU 144 200	Ø 20 mm	200 cm
TU 144 250	Ø 20 mm	250 cm

Workplace rope

Rope diameter:	Ø 20 mm
MBS:	124 kN
WLL:	30 kN
Material:	polyester Polyester

Ref.:	TU 145
-------	--------



TU 811

Prusik

EN 795



L = 80 cm, 85 cm, 90 cm, 100 cm

Rope diameter: Ø 10 mm

Material: aramid, polyester

Ref.	Length::
TU 811 080	80 cm
TU 811 085	85 cm
TU 811 090	90 cm
TU 811 100	100 cm

TU 810

Prusik

EN 795



L = 80 cm, 85 cm, 90 cm, 100 cm

Rope diameter: Ø 10 mm

Material: aramid, polyester

Ref.	Length::
TU 810 080	80 cm
TU 810 085	85 cm
TU 810 090	90 cm
TU 810 100	100 cm

TU 812

Prusik

EN 795, EN 354



L = 80 cm, 85 cm, 90 cm, 100 cm

Rope diameter: Ø 10 mm

Material: aramid, polyester

Ref.	Length::
TU 812 080	80 cm
TU 812 085	85 cm
TU 812 090	90 cm
TU 812 100	100 cm

CD 101

Double transport pulley

EN 12278



Double pulley CD 101 is a device designed for horizontal transportation with the use of textile rope, max. diameter of 13 mm.

Dimensions:	103 x 90 x 33 mm
Weight:	250 g
Max. Allowed speed:	10 m/s
Max. Rope diameter:	13 mm

Ref.	
CD 101	

CD 201, CD 202

Chest ascenders

EN 567



CD 201 CD 202

CD 201 and CD 202 chest ascenders with a grip for climbing the rope or as safety gear. Used for ropes diameter of 8-13 mm. Equipped with rope-locking mechanism.

Dimensions:	103 x 90 x 33 mm
Weight:	220 g
Rope diameter:	Ref. \varnothing 8 - 13 mm

Ref.	
CD 201	
CD 202	

CD 211, CD 212

Handled ascenders

EN 567



CD 211 CD 212

CD 211 and CD 212 ascenders with a grip for left - and right - handed people for climbing the rope vertically or at an inclination. Used for ropes diameter of 8-13 mm. Equipped with rope-locking mechanism.

Dimensions:	207 x 100 x 28 mm
Weight:	280 g
Rope diameter:	\varnothing 8 - 13 mm

Ref.	
CD 211	
CD 212	

CD 303

Descent device



Descender for lowering on a line.

Dimensions:	131 x 74 mm
Rope diameter:	\varnothing 8 - 13 mm
Weight:	80 g

Ref.	
CD 303	

CD 401

Small Rigging Plate

EN 354



Dimensions:	90 x 83,5 mm
Weight:	62 g
Strength:	36 kN
Material:	aluminium

Ref.:	CD 401
-------	--------

CD 402

Medium Rigging Plate

EN 354



Dimensions:	100 x 159 mm	Ref.:	CD 402
Weight:	240 g		
Strength:	50 kN		
Material:	aluminium		

CD 403

Large Rigging Plate

EN 354



Dimensions:	149 x 248 mm	Ref.:	CD 403
Weight:	500 g		
Strength:	50 kN		
Material:	aluminium		

TU 300

Auxiliary hook

The auxiliary hook is designed to suspend the equipment and accessories required for work execution on the full body harness. It facilitates management of tools when the employee moves around during tree felling, with his hands free, he can move more safely.

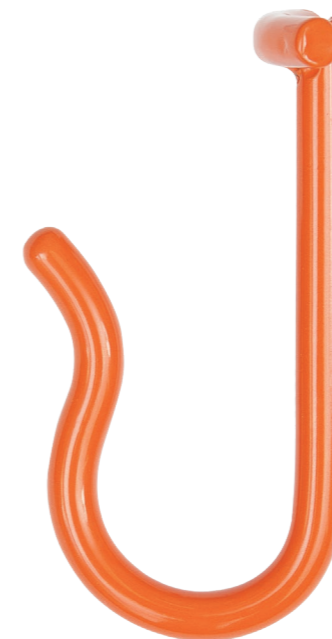

Max. Working load - WLL:	50 kg	Ref.:	TU 300
Max. Load:	10 kg		
Breaking force - MBS	500 kg		

AY 100

Tool grip



AY 100 – tool grip:

- pinned into the belt or straps of the harness, full body harness,
- ensures stable position during work execution,
- allows easy access,
- ensures optimum order of tools.

Max. Working load - WLL:	25 kg
Max. Load:	5 kg
Breaking force - MBS:	90 kg

Ref.:

AY 100

AY 023 Steel tool cable



Ref.:

AY 023

AY 032 Fast



Dimensions:	149 x 248 mm
Weight:	500 g
Strength:	50 kN
Material:	aluminium

Ref.:

AY 032

AY 061

Tool belt grip

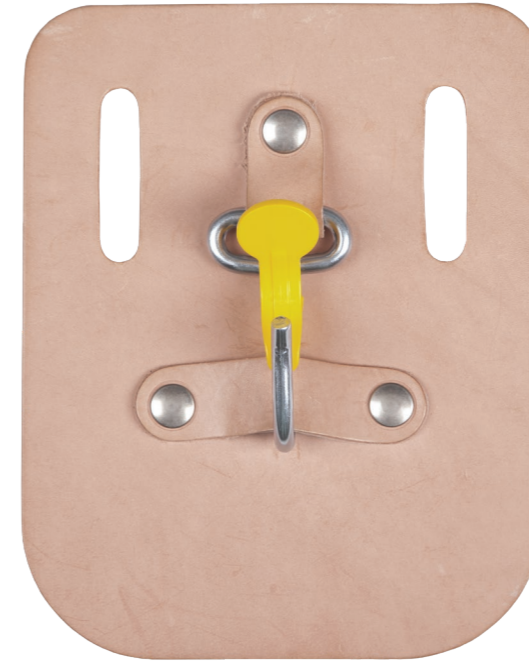

Tool belt to be fixed to the harness.

Dimensions::	170 x 200 mm
Weight:	85 g
Material:	natural leather
Width of the webbing:	40-55 mm

AY 061

KLK 100, KLK 200



Strenght of material: 25 kN

Material: aluminium

Ref.:

KLK 100

KLK 200

AY 080 Arborist throw bag



Material: steel, lead, polyester

Ref.	Weight:
AY 080 220	220 g
AY 080 280	280 g
AY 080 340	340 g
AY 080 400	400 g
AY 080 460	460 g

AY 081 Arborist throw bag



Material: steel, lead, reinforced PVC

Ref.	Weight:
AY 081 220	220 g
AY 081 280	280 g
AY 081 340	340 g
AY 081 400	400 g
AY 081 460	460 g

AY 082 Arborist throw bag



Material: steel, lead, genuine leather, polyester

Ref	Weight:
AY 082 220	220 g
AY 082 280	280 g
AY 082 340	340 g
AY 082 400	400 g
AY 082 460	460 g

AY 083 Solid rubber arborist throw



350 g orange
450 g red
250 g blue

Dimensions:	127 x 51,5 mm
Weight:	250 g, 350 g, 450 g
Material:	rubber, stainless steels
MBS:	500 kg of handle to the cord

Ref.	Weight:
AY 083 250	250 g
AY 083 350	350 g
AY 083 450	450 g

TU 325 Small anchor



Material:	powder-coated steel
Weight:	15 g

TU 325

TU 326 Large anchor



Material:	powder-coated steel
Weight:	22 g

TU 326

TU 360

Tree wedge

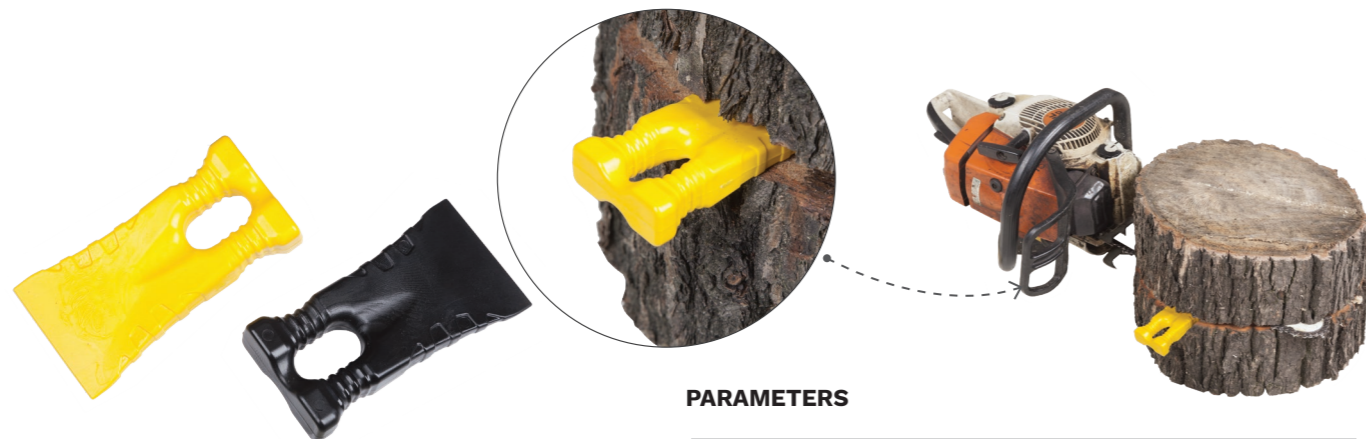

PARAMETERS

Material:	high impact thermoplastic
Weight:	46 g
Dimensions:	93 x 49 x 18 mm
Colours:	yellow, black

Ref.:

TU 360

TU 360 is a pocket-size wooden wedge, made of durable plastics, helpsto release the jammed saw guide without the risk of damaging the chain,even in case of contact with it. Compact size and low weight allows touse both on the ground and on the tree. large, central hole allows forattaching the wedge to the harness by means of majority of holdersof tools and carabineers.

TU 350

Cone wedge



PARAMETERS

Material:	thermally tempered steel
Weight of the set:	642 g (cone wedge and rope)
Dimensions of the cone:	170 x 35 mm
Tapered diameter:	35 mm
Tape length:	130 cm (expanded)

Ref.:

TU 350

TU 350 is a specifically-designed light cone wedge for useon the ground and on trees. It is intended for small and medium-sizedtrees. After a cut is made in the tree, the cone wedge is inserted whichmakes it easier to release the cut saw guide or enables to control treetilting. The cone wedge may be turned using a ratchet spanner, impactgun or a high-torque drill driver equipped with a 1/2" squared pin.The cone wedge is made of thermally-hardened steel and its surfaceis protected by thermal and chemical processing (black oxidetreatment). It is easy to fasten to a harness using a flexible rope.

TU 320

Rope protector



Material:	natural leather
Weight:	290 g
Ref.:	
TU 320	

TU 321

Rope guard



TU 321 - rope guard made of leather and PVC is suitable for rope of self-locking device and complies with EN 353-2 (LINOSTOP II, ACOIO), preventing the rope from wearing out.

Material:	leather and reinforced PVC
Ref.:	
TU 321 050	50 cm
TU 321 100	100 cm

TU 322

Rope guard



TU 322 - rope guard made of leather with Velcro straps is suitable for rope of self-locking device and complies with EN 353-2 (LINOSTOP II, ACOIO), preventing the rope from wearing out.

Material:	leather and polyester
Ref.:	
TU 322 050	50 cm
TU 322 100	100 cm

TU 323

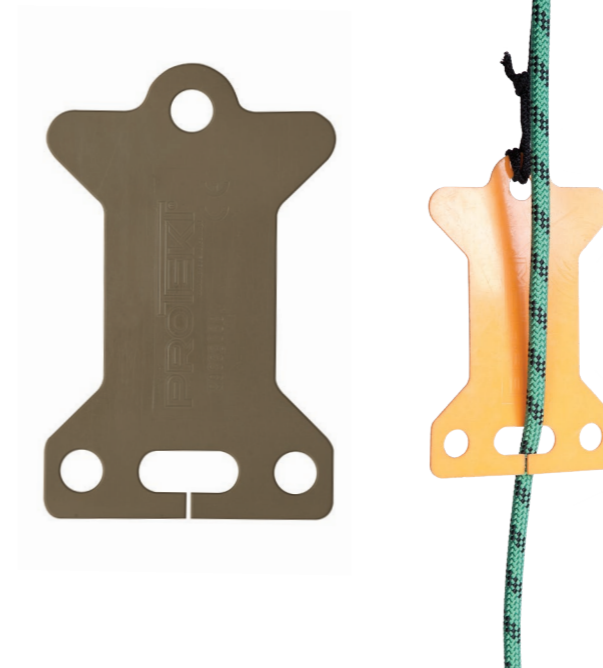

Pad, rope protector



The pad is designed to serve as a multifunctional patch enabling i.e. comfort storing of laces and thin lines, protecting sharp edges when using lifelines, guarding rope ends against damaging by sheave blocks, etc.

Material:	PS + PVC
Ref.:	
TU 323	

COLORS AVAILABLE

	
orange	khaki

AX 011, AX 012

Transport pack



Material: reinforced PVC

COLORS AVAILABLE



Ref.	Dimensions:	Volume:
AX 011	300 x 300 x 600 mm	33 l
AX 012	400 x 400 x 800 mm	81 l

AX 011K

Transport pack with collar



Material: reinforced PVC

COLORS AVAILABLE

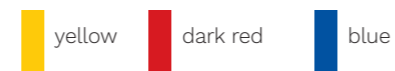

Ref.	Dimensions:	Volume:
AX 011K	300 x 300 x 600 mm	33 l

AX 013A

Equipment carrying bag



Bag made of reinforced PVC.

Equipment:

- foil pocket inside for storing the user manual;
- adjustable shoulder strap with cushion;
- additional adjustment tape for greater comfort of use.

Material: reinforced PVC

COLORS AVAILABLE

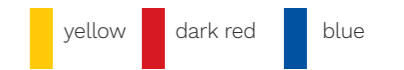

Ref.	Dimensions:	Volume:
AX 013A	600 x 450 x 450 mm	20 l

AX 023

Transport pack for climbing spikers



Material: reinforced PVC

Ref.	Dimensions:
AX 023	470 x 320 x 160 mm

AX 070

Transport pack for climbing spikers



Ergonomic arboristic bag:

- breathable stitching cushion for extra comfort,
- 2 combustion saw pockets,
- convenient carabine mounting system,
- removable bottom.

Material: 90% PVC, 10% polyester

Weight: 1,49 kg

Ref.	Dimensions:	Volume:
AX 070*	600 x 310 x 250 mm	40 l

* without carabiners

AX 080



Ergonomic arboristic bag:

- double chamber for easy arrangement of the loading area,
- 5 outer pockets,
- possibility of dividing the backpack (2 separate baskets),
- comfortable carrying ears.

Material: polyester

Weight: 2,68 kg

Ref.	Dimensions:	Volume:
AX 080	800 x 350 x 350 mm	80 l

AX 700

Arborist basket



AX 700 80
80
liters

AX 700 50
50
liters

AX 700 30
30
liters

Material: textile tape / plastic

Weight: 5,28 kg 4,32 kg 3,00 kg

Dimensions: 670 x 440 x 345 mm 490 x 440 x 345 mm 310 x 440 x 345 mm

Capacity: 80 l 50 l 30 l

- shoulder strap,
- handle for horizontal carrying,
- two handles for carrying, the basket in hand,
- adjustable collar with a drawstring fastened with press studs.



AX 701 15

Arborist basket

15
liters



Equipment:

- 3 types of carrying handles,
- 6 tool holders,
- adjustable collar with drawstring,
- transparent pocket,
- breathable material,
- plastic rigid bottom.

Material: polyester, fabric / PVC plawil, plastic

Weight: 620 g

Dimensions: 390 x 220 mm

Capacity: 15 l

Ref.:

AX 701 15

AX 701 30

Arborist basket

30
liters



Equipment:

- 3 types of carrying handles,
- 6 tool holders,
- adjustable collar with drawstring,
- transparent pocket,
- breathable material,
- plastic rigid bottom.

Material: polyester, fabric / PVC plawil, plastic

Weight: 940 g

Dimensions: 430 x 300 mm

Capacity: 30 l

Ref.:

AX 701 30

AX 801

Ballast bag



Ballast bag for a rope of a rope grab device acc. to EN 353-2 standard. The bag may be filled e.g. with sand up to 5 kg. The bag is made of reinforced PVC.

Material: reinforced PVC

COLORS AVAILABLE

yellow
 dark red
 blue

Ref.:

AX 801



SCAN THE QR CODE
AND VIEW CATALOG

GET
BAG

Transport sacks
 Transport backpacks
 Transport bags
 Tool and transport bucket
 Equipment covers bags
 Arborist baskets
 Transport sacks Dry Bag
 Tool lanyards
 Tool bags and belts

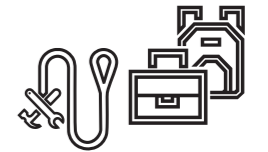

2024

7

TU 600, TU 610

Hammocks

TU600

Hammock without mosquito net



Available colors: green

orange

TU610

Hammock with mosquito net



Available colors: green

orange

Hammocks made in Poland of breathable Ripstop material, durable, lightweight and waterproof.
250 kg load capacity

Material:	ripstop
Weight:	TU 600 - 700 g / TU 610 - 800 g
Dimensions:	330 x 150 mm

Ref.:

TU 600

TU 610

The TU600 and TU610 touring hammocks are among the lightest and most compressible models and are suitable for any terrain, garden or balcony. Made of ultra-thin nylon with a durable RIPSTOP weave they are highly durable and can carry a maximum load of 250 kg.

The entire set, which includes a hammock, sturdy aluminum carabiners, tie-down straps, and a compression and waterproof bag, is an essential piece of equipment for every camper. It takes up very little space and is so light that you will not feel it in your luggage.

The TU600 and TU610 travel hammocks are models that have been refined in every detail. Their weight has been significantly reduced, making them a highly competitive solution among those currently available in the outdoor market. The nylon fabric is highly breathable and efficiently transports moisture to the outside, keeping the climate close to the body in optimum comfort.



RS 220

Arborist's trolleys



The arborist's trolley is a multifunctional solution for timber transport. It has been proven both in forest sites and in a homestead garden. It is an excellent solution for transporting materials in the back yard with difficult access. It accelerates transport ensuring high labour culture.

Load capacity:	max 500 kg	
Length:	783 - 1683 mm	
Height:	892 mm	Ref.:
Width:	855 - 1020 mm	RS 220

RS 221



Material: reinforced PVC

Capacity:	max 500 kg
Length:	1760 - 2230 mm
Height:	1135 mm
Width:	800 - 935 mm

Ref.:
RS 221 - stroller without bag
RS 221W - bag

The logo for TreeUP, featuring the word "Tree" in a bold, sans-serif font, followed by a stylized tree icon with an upward-pointing arrow, and the letter "P" in a bold, sans-serif font.

EQUIPMENT FOR ARBORISTS AND TREE SURGEONS

WWW.TREEUP.COM

PROTEKT[®]

USE IMAGINATION | PROTECT YOUR LIFE

WWW.PROTEKT.EU

OFFICE

Skromna 6
93-405 Lodz
Polska

Phone: +48 42 29 29 500
fax +48 42 680-20-93

CORRESPONDENCE ADDRESS:

PROTEKT Grzegorz Łaskiewicz Sp. z o. o.
Starorudzka 9,
93-403 Lodz
Poland

WAREHOUSE

Gombrowicza 6
93-405 Lodz
Poland

EXPORT SALES DEPARTMENT

export@protekt.com.pl
Phone: +48 42 29 29 500
fax +48 42 680-20-93

JOANNA KRASKA

asia@protekt.com.pl
Phone: +48 42 29 29 508

ANNA BRACICHOWICZ

anna@protekt.com.pl
Phone: +48 42 29 29 542

AGATA ŁUKASIEWICZ

agata@protekt.com.pl
Phone: +48 42 29 29 510

